

# *Operator's manual* *for the User*

## ***ISDN PBX Systems***

***COMmander® Basic***

***COMpact 4410 USB***

***COMpact 2206 USB***

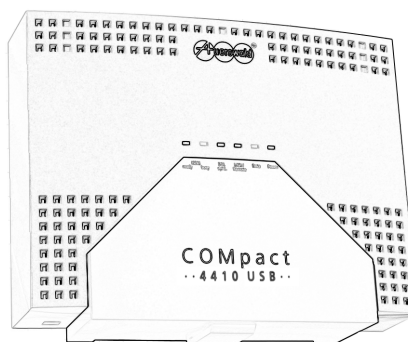
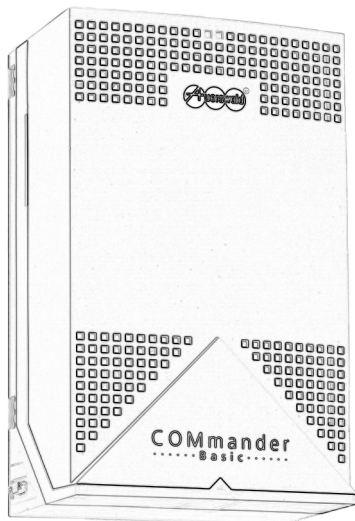

## Abbreviations used in the Manual

CF	<b>C</b> all <b>F</b> orwarding
DDI	<b>D</b> irect <b>D</b> ialling <b>I</b> n number in case of a PTP connection
GSM	<b>G</b> lobal <b>S</b> ystem for <b>M</b> obile Communications
PD	<b>P</b> ulse <b>D</b> ialling
DTMF	<b>D</b> ual <b>T</b> one <b>M</b> ulti- <b>F</b> requency dialling
MSN	<b>M</b> ultiple <b>S</b> ubscriber <b>N</b> umber in case of a PTMP connection
NT	<b>N</b> etwork <b>T</b> ermination unit for the basic connection
VoIP	Voice over <b>I</b> nternet <b>P</b> rotocol

## Symbols used in the Manual



Warning: Hazardous voltages will be present!



Warning: General danger sign.



Additional advice.



Function may be defined also configuration dependent (see [chapter Make Settings depending on switchable Configurations on page 23](#)).



Function is also executable with an existing T-Net key/menu on the analog telephone (see [chapter Analog T-Net-Telephones on page 9](#)).



Function is also executable with an existing function keys (or menu) on the ISDN telephone (see [chapter ISDN Telephones on page 9](#)).

### **General limitation of legal responsibility and application**

Auerswald products are not designed or intended for use in any life-saving and/or life support application and/or nuclear facility. When using our products for such applications a written agreement by Auerswald for each individual case is necessary in advance.

### **Copyright**

Passing on or duplicating the contents of this manual or parts of it is only allowed with our express written permission. Offenders will be subject to claims for damages. All Rights Reserved.

© Auerswald GmbH & Co. KG, 38162 Cremlingen, 2006

### **Accessory and Service components**

These are available at your authorized dealer or in the Internet shop distriCOM at <http://www.districtcom-online.de> (Only shipping in Germany.)

<b>Introduction</b> .....	7
<b>Usage and Functionality</b> .....	7
Functions and Features of the default Device Configuration .....	7
T-Net-Functions of analog Telephones supported by the PBX.....	8
ISDN Features supported by the PBX .....	8
<b>Instructions for using the Manual</b> .....	8
Use of the Manual.....	8
Symbols used in this Manual .....	8
<b>Differences using various Telephones</b> .....	9
Analog Telephones (Pulse Dial and DTMF) .....	9
Analog T-Net-Telephones.....	9
ISDN Telephones.....	9
System Telephones .....	9
<b>Telephoning</b> .....	10
<b>You like to react to an inbound Call</b> .....	10
Your Telephone rings.....	10
Other internal Telephones ring (Pickup) .....	10
An Answering Machine already accepted a Call (Takeover) .....	10
Call Waiting Tone in the Receiver.....	10
<b>You like to make an internal Call</b> .....	11
Call an internal Telephone .....	11
Generate Call Waiting Signals on a busy internal Telephone.....	11
<b>You like to make an external Call (Call via Exchange Line)</b> .....	11
Call an external Number .....	11
Call an external Number via Short-Code Dial Number (Dialling Assistance).....	12
Start external Calls without Presentation of your calling Number .....	12
<b>You like to separate the Charges of external Calls to different Accounts</b> .....	12
Selecting Exchange Lines before starting an external Call ( <i>COMpact 4410 USB</i> and <i>COMmander Basic</i> only).....	12
<b>The called Person does not take the Call</b> .....	12
The called Subscriber in a Query does not take the Call – Finish the Call .....	13
Start a Recall on no Reply for internal Telephone Call .....	13
Start a Recall on no Reply for external Calls (CCNR) .....	13
<b>You are Dialling a Number and are Hearing the busy Tone</b> .....	13
Start Recall on Busy for internal Telephone Call .....	14
Starting Recall on Busy via Public Exchange for external Connection (CCBS).....	14
Reserve Exchange Line for the next Call on busy Exchange Lines .....	14
Start a Priority Call to a Telephone protected by the Do-Not-Disturb Service .....	14
The Subscriber called in a Query is busy - Finishing the Call.....	14
<b>You are in a Conversation</b> .....	15
Start second call (Query Call) .....	15
Other internal Telephones are ringing (Pickup if you are in another Call) .....	16
Parking external Call on the external S <sub>0</sub> Port (For Point-to-Multipoint Connection only) .....	16
<b>You are in a Call and like to Transfer it</b> .....	16
Transfer a Call with prior Notice.....	17
Transfer external Call without Announcement to an internal Telephone (Blind Transfer) .....	17
Transfer an external Call to a currently unknown internal Target (Open Query) .....	17
Transfer external Call to an external Connection (External to External Transfer) .....	18
Calling an internal third Calling partner and transfer to the second calling Partner .....	18
<b>You have two Calls (Query Call)</b> .....	19
Transfer both calling Partners.....	19
Finish one of both Calls .....	19
Talking alternately with both Calling Partners (Alternation) .....	19
In the Receiver is a Knocking Tone - Reject the Waiting Caller .....	19
Talk to both Call Partners at the same Time (Conference).....	20
<b>You have a Conference Call</b> .....	20
Transfer both calling Partners.....	20
Finish the Call with only one calling Party.....	20
Talk alternately with both Calling Partners (Alternation) .....	21

<b>Talking to a Visitor at the Door (Door Terminal Call)</b> .....	21
Your Telephone rings with the Door Bell Rhythm .....	21
The Door Bell rings .....	21
The Visitor has not pressed the Door Bell Key .....	22
You are in a Conversation and the Door Bell rings .....	22
Open the Door during a Door Call .....	22
Change to another Door during a Door Call .....	22
<b>You like to take an Emergency Call</b> .....	22
Your Telephone rings with the Alarm Rhythm .....	22
<b>Settings</b> .....	23
<b>You like to use different PBX Configurations (Day, Night etc.)</b> .....	23
Make Settings depending on switchable Configurations .....	23
Switching over the Configurations by Hand .....	23
Activate automatic Configuration Switching .....	24
Enquire the active Configuration .....	24
<b>You like to stay reachable during your Calls</b> .....	24
Permit/Forbid the Call Waiting (Knocking) for the Telephone .....	24
<b>You do not like to present your Telephone Number to the Called Party</b> .....	24
Restrict the calling Number Presentation for all of your outbound Calls .....	24
<b>Somebody should be reachable for internal/external Callers to your Telephone Number (Subscriber Call Forwarding)</b> .....	25
Forward Telephone „unconditional“ to an internal/external Telephone because you are absent .....	25
Forward Telephone „on Busy“ to an internal/external Telephone because you are currently Telephoning .....	26
Forward Telephone „on no Reply“ to an internal/external Telephone in Case of a short Absence .....	26
Switch the already configured Subscriber Call Forwarding on/off .....	26
Switch off all active Subscriber Forwarding Settings for the Telephone .....	26
Receive Calls at another internal Telephone (Follow-me) .....	26
Programming Subscriber Call Forwarding via an external Telephone if you are „Out of Office“ .....	27
<b>External Callers should always reach Somebody when calling your external Number (MSN/DDI Call Forwarding)</b> .....	28
Forward Exchange Line Number „unconditional“ to an external Telephone because nobody is there .....	28
Forward Exchange Line Number „on Busy“ to an external Telephone if the internal Telephones are busy at the Moment .....	28
Forward an Exchange Line Telephone Number „on no Reply“ in Case of a short Absence .....	28
Switch the already configured MSN/DDI Call Forwarding on/off for an Exchange Line Telephone Number .....	29
Switch off all active MSN/DDI Call Forwarding Settings for one Exchange Line Number .....	29
Program MSN/DDI Call Forwarding from an external Telephone if you are „Out of Office“ .....	29
<b>You do not like to be called</b> .....	30
Do-Not-Disturb Service for internal and external Calls .....	30
Deactivate Do-Not-Disturb for special Persons for external Calls (VIP List) .....	30
Prevent to be called from certain Individuals (Robinson List) .....	30
<b>You like to save Call Charges with Least Cost Routing (LCR)</b> .....	31
Activate external Call Routing via several Network Providers (Automatic Least Cost Routing) .....	31
<b>You like to control Call Charges</b> .....	31
Configure Call Allowance .....	31
Enquire Status of the Call Allowance .....	32
Enquire Call Allowance Accounts .....	32
Enquire Call Charge Sum .....	32
Enquire Charge Sum .....	32
Delete Charge Sum .....	32
<b>You like to retrieve and analyse Call Charge Data</b> .....	32
Start-/Stop Command for the continuous Call Data Output .....	33
Call Data Printing on Demand .....	33
Delete entire Call Data Memory .....	33
<b>You like to use the Serial Interface for Special Functions</b> .....	34
Select Operation Mode of the Serial Interface .....	34
<b>You like to simplify the Dialling of external Numbers</b> .....	34
Enter public Short-Code Dial Numbers .....	35
Enter private Short-Code Dial Numbers .....	35
Enter Emergency Short-Code Dial Numbers .....	35

<b>You like to use the Wake-up Function of the PBX</b> .....	35
Configure Wake-up Time and activate the Function for one single Wake-up.....	36
Configure Wake-up Time and activate the Function for repetitive Wake-up.....	36
Switch on Wake-up.....	36
Deactivate Wake-up Function.....	36
Enquire Wake-up Time.....	37
<b>You like to configure internal Dial Tones and listen to the Result</b> .....	37
Change internal Dial Tone.....	37
Listen to internal Dial Tones.....	38
<b>You like to configure Ringer Rhythms and listen to the Result</b> .....	38
Configure Ringer Rhythm for internal Calls.....	39
Change Ringer Rhythm for external Calls.....	39
Listen to Ringer Rhythms for internal, external and Alarm Calls.....	39
<b>Make a Call without any Dialling Operation (Automatic Dialling / Hot Line)</b> .....	39
Configure Automatic Dialling / Hot Line.....	40
Switch on/off Automatic Dialling / Hot Line.....	40
<b>You want to listen into a Room (Room Monitoring)</b> .....	40
Enable the Room Monitoring on an internal Telephone.....	40
Listen into the Room from an internal Telephone.....	41
Listen into the Room from an external Telephone.....	41
<b>Door Terminal Calls should always reach you</b> .....	41
Connect the Door Terminal to an external Subscriber (External Call Forwarding from the Door Terminal).....	41
<b>Use the Remote Switching Relay (via Telephone)</b> .....	41
Remote Switching via internal Telephone.....	42
Remote Switching via external Telephone.....	42
<b>You like to use the Security Functions</b> .....	43
Activate Alarm via internal Telephone.....	43
Activate Alarm via external Telephone.....	43
<b>You like to change the Music on Hold/Announcement</b> .....	44
Recording internal Music on Hold with the PBX ( <i>COMpact 4410 USB and COMmander Basic only</i> ).....	44
Recording the Music on Hold Announcement via Telephone ( <i>COMmander Basic only</i> ).....	45
Configure and mix Music on Hold and Announcement.....	45
Configure the Delay Time between Announcements.....	45
Select and listen to internal Music on Hold ( <i>COMpact 4410 USB and COMpact 2206 USB only</i> ).....	46
Listen to Music on Hold and Announcements.....	46
Record the Alarm Announcement by Telephone and listen to it ( <i>COMpact 4410 USB and COMmander Basic only</i> ).....	47
<b>You like to set Date and Time</b> .....	47
<b>You like to park Calls with a Parking Code</b> .....	47
Set Code Digits.....	47
<b>Special Functions for Business Applications</b> .....	48
<b>Reception and Secretary Function and Text before Answering</b> .....	48
Internal Subscriber is busy – Put the external calling Partner into the Waiting Loop.....	48
Activate/deactivate the Automatic Reception.....	48
Recording the Welcome Message (Announcement before Answering) with a Telephone.....	49
<b>Use Call Data to separate Call Charges</b> .....	49
Start external Call with private Exchange Line Access.....	49
Change private Password.....	50
Start external Call with Project Assignment.....	50
<b>Announcements via Loudspeaker and System Telephones</b> .....	50
Call an internal System Telephone via InterCom Function (Announcement/handsfree Operation).....	50
Make a Loudspeaker Announcement.....	51
<b>Save Money and get Information away from Home</b> .....	51
Start a Call Through Connection.....	51

<b>Call Groups (Teams)</b> .....	52
Log in/out as a Member of a Group if you are only Member of one Group.....	53
Log in/out as a Member of a Group if you are Member of several Groups.....	53
Log out all Members of a single Group.....	54
Forward Group „unconditional“ to an internal/external Telephone because all Group Members are absent.....	54
Forward Group „on Busy“ to an internal/external Telephone because all Telephones „logged in“ are currently Telephoning.....	54
Forward Group „on no Reply“ to an internal/external Telephone because all Group Members are absent for a Moment.....	54
Forward Group „if all Subscribers are logged out“ to e.g. an Answering Machine.....	54
Switch a previously configured Group Call Forwarding on/off.....	55
Switch off all active Call Forwarding Settings for one Group.....	55
Program Group Call Forwarding with an external Telephone if you are „Out of Office“.....	55
<b>Hotel Functions for Reception and Room Telephones</b> .....	56
Configure the Wake-up Time with the Room Telephone.....	57
Delete the Wake-up Time with the Room Telephone.....	57
Enter the Room Status with the Room Telephone.....	57
<b>Installation and Use of the bundled Software</b> .....	58
<b>Connection Options between PC and PBX</b> .....	58
Connection via serial Port (V.24).....	58
Connection via the USB Interface (only COMpact 4410 USB and COMpact 2206 USB).....	58
Connection via ISDN PC-Controller (CAPI 2.0).....	58
Connection via a <i>COMfort 1200/2000</i> or <i>COMfortel 2500</i> .....	58
<b>Installation of the Software</b> .....	59
Minimum Requirements for the PC.....	59
<b>Functionality of <i>COMtools</i></b> .....	60
Load Data and Store.....	60
Description of Short-Code Dial Numbers.....	60
Description of special Numbers.....	60
<b>Call Data Management with <i>COMlist</i></b> .....	61
Update Data Base.....	61
Description of the Filters.....	61
<b>Least Cost Routing Software <i>Soft-LCR</i></b> .....	61
Configure LCR with <i>Soft-LCR</i> .....	61
<b>Service Functions, Troubleshooting</b> .....	62
<b>Initialize Settings</b> .....	62
<b>Call the Service Technician and ask for a Modification of the Configuration</b> .....	62
Remote Programming.....	62
<b>Perform an automatic PBX Firmware Update</b> .....	62
<b>Request Firmware Version</b> .....	63
<b>How to connect the Telephones</b> .....	63
Connecting analog Devices.....	63
Connecting ISDN Devices.....	63
<b>Cleaning of the Casing</b> .....	64
<b>Frequent Problem Sources</b> .....	64
You are hearing an unexpected Tone.....	64
Telephoning impossible.....	65
The Telephone can not be called.....	65
Query or Transfer not possible.....	66
Pickup is not possible.....	66
You cannot identify Door Bell ringing.....	66
PBX is not programmable.....	66
Error Messages for USB.....	66
<b>Digit Code Index</b> .....	67
<b>Telephoning</b> .....	67
<b>Settings</b> .....	68
<b>Index</b> .....	72

## Dear Customer!

When you read this operation instructions probably the PBX has already been installed, started and absolutely configured to your requirements. In this case please take a little bit of time and read the instruction of this manual. Then simply try some of these functions and familiarize yourself with the PBX.

If your requirements change in one way or another so that some settings need to be changed, please contact your authorized dealer. Changes that can be executed with the configuration program *COMset* can be done via an existing external telephone connection (remote programming).

If you like to extend your PBX with additional modules or if you like to execute other settings, please instruct your supervisor to do these operations. The same is recommended if your PBX has not been configured and has not been put into operation. Besides this pay attention to the following advice by all means:



### Warning:

**Touching the voltage carrying conductors or connectors may be dangerous to life.**

**As soon as the device is connected to the 230 Volt socket dangerous voltages may be present in the device (e.g. ringer voltage).**

**- The case may only be opened by authorized personnel<sup>1</sup>.**

**- Installation work inside the open case as well as maintenance services involving the keys inside the case are only allowed to be executed by authorized personnel<sup>1</sup>.**



**The device described in this manual is made for the indicated use only. If you are not sure about the intended purpose of the product, please contact your dealer.**

**Please pay attention to the security advice in the Installation and Configuration Manual also.**

<sup>1</sup> Authorized personnel: These are persons that are trained for this purpose (e.g. certified electricians). They must have the necessary knowledge about the work in an area with potentially hazardous voltage. They must also have the knowledge about the latest electrical safety standards and requirements.

## Usage and Functionality

The PBX is a PBX that is designed for the connection to the digital telecommunications network ISDN (Point-to-Point connection and/or Point-to-Multipoint connection). It enables the switching from the public communication net to different internal devices. The so-called terminals may be system telephones, ISDN devices as well as analog devices.

Thanks to functions like e.g. Short-Code Dialling, Conference, splitting and internal free of charge connections the PBX makes the daily telephone communication simple, comfortable and time saving. Additional to the telephoning the PBX offers numerous functions such as call charge recording.

The PBX can be configured to your special personal requirements with the configuration software *COMset*. Three further PC programs allow to you to comfortable manage call charge data, Short-Code Dialling, Call Allowance, Wake-up calls, Music on Hold and the data for the automatic Least Cost Routing.

With the bundled ISDN application package you can use the possibilities of the integrated USB interface (COMcompact 2206 USB and COMcompact 4410 only), and the most important tasks of modern data communication (fax, answering machine, data transfer) can professionally be controlled via PC.



*The scope of functions described here is only completely usable with a professional installation and a correct configuration of the PBX and the connected PC. We highly recommend to consult your authorized dealer first.*

*Please ask your network operator about the availability of some ISDN service attributes. Some of these functions may be available for an extra fee.*

*There may be some incompatibility in combination with terminals and devices of other vendors that adversely influence the usability of functions.*

*To fully utilize the scope of functions described here, the PBX system must have the **Software version 1.8D** or newer and the system telephone must have the software version 2.2B or newer (you may receive information about these versions via system telephone). If this is not the case, please perform a firmware update of the respective device.*

### Functions and Features of the default Device Configuration

- 1 external S<sub>0</sub> port and 1 internal S<sub>0</sub> port<sup>2</sup> (COMcompact 2206 USB and COMcompact 4410 USB) or S<sub>0</sub> ports that can alternatively be used as internal or as external S<sub>0</sub> ports (COMcommander Basic).

<sup>2</sup> An S<sub>0</sub> port contains two voice/data channels. Therefore two connections are possible on an S<sub>0</sub> port at the same time. If two internal ISDN subscribers talk together on one internal S<sub>0</sub> port, there will be two connections.

- Connecting possibilities for 6 (COMcompact 2206 USB) or 10 (COMcompact 4410 USB) or 8 (COMcommander Basic) analog subscribers (Telephones, fax machines, answering machines, modems) and 1 system display SD-420 (Auerswald accessory).
- Free configurable telephone numbers (10-59/100-599) for the internal subscribers/groups.
- Charge control by 6 different classes of service, Blocking numbers, Release numbers and special Short-Code Dialling authorization as well as by setting of a call allowance account.
- Watching the charging information via PC or via telephone (AOCE or AOCD necessary). Metering pulse for analog telephones.
- Call data management via PC software. Recording of 3000 call data entries in a power failure proof call data memory.
- Selection of the telephone number presented to the caller or the person you called.
- Dialling assistance by a power failure proof Short-Code Dialling memory or setting of direct public exchange telephones.
- Wake-up and timer functions via internal clock. Automatic setting of summer/winter time.
- Music on Hold, 7 internal (COMcompact 2206 USB and COMcompact 4410 USB only)
- Music on Hold downloadable as a .wav-file into the PBX (COMcompact 4410 USB and COMcommander Basic only).
- Music on Hold, external via audio input (COMcommander Basic: Not with the basic unit).
- Music on Hold plus announcement
- Text before answering and automatic reception (COMcompact 4410 USB and COMcommander Basic only).
- Announcement function via audio output (COMcommander Basic: Not with the basic unit).
- Different ringer rhythms for the distinction of the calls.
- Protection against unauthorized programming/telephoning with passwords and programming protection.
- Room monitoring and programming of the Call Forwarding from external telephones.
- Optimal availability due to internal and external Call Forwarding, Call Waiting and Busy-on-Busy.
- Call Waiting for external and internal calls (delayed or immediately for analog door terminal ports)
- Security in emergency situations by alarm announcement, baby/senior call, emergency Short-Code Dialling memory, emergency priority call and priority call in case of Do-not-Disturb service.
- Call Forwarding, Splitting, Conference via 2nd B channel.
- Call protection against certain callers.
- Group formation of internal subscribers.

- Up to 57.600 bps data transfer (V.90) on the analog extensions.
- Exchange line reservation, pickup and explicit call transfer to an external phone.
- Dialling support by PC (TAPI).
- PBX software update via PC or telephone connection.
- Remote programming via exchange line from the outside.
- Internet Telephony (VoIP) via *Auerswald Box*
- Least Cost Routing
- Routing of Internet Telephony (VoIP) calls via *Auerswald Box* and mobile phone calls via GSM gateway
- Integrated data interface (ISDN PC adapter functions) via USB interface (*COMpact 2206 USB* and *COMpact 4410 USB* only).
- NDIS-WAN-driver (*COMpact 2206 USB* and *COMpact 4410 USB* only) for
  - channel bundling, internet access with up to 128 kBit/s,
  - dynamic bandwidth use in combination with Windows 2000.

**T-Net-Functions of analog Telephones supported by the PBX**

If you use a T-Net compatible analog telephone, these functions will be able to be executed via the existing function keys.

- Permit, accept, refuse Call Waiting.
- Alternation.
- Start conference with 3 persons.
- Start Query, finish.
- Configure Subscriber Call Forwarding.

- Configure connection without dialling (baby call).
- Start recall on busy.
- Suppress telephone number presentation once.

**ISDN Features supported by the PBX**

- Conditional suppression of the own telephone number presentation (CLIR).
- Parking (TP) on the PTMP connection or on the internal S<sub>0</sub> port.
- Call Forwarding on busy (CFB), if nobody takes the call (CFNR), always (CFU).
- Transmission of the connection charges during (AOCD) and at the end (AOCE) of the connection.
- Recall on busy (CCBS) and on no reply (CCNR).
- Telephone number display (CLIP) on SD-420, system telephones, internal ISDN units and analog telephones (special analog terminals are necessary that support CLIP).
- Name display (CNIP) on system telephones, internal ISDN units and analog telephones (special analog terminals are necessary that support CNIP)<sup>1</sup>
- X.31 on the internal S<sub>0</sub> port or X.25 in the D channel (*COMpact 2206 USB*, *COMpact 4406 DSL* and *COMpact 4410 USB* only)

 Please ask your network operator about the availability of some ISDN service attributes. Some of these functions may be available for an extra fee.

<sup>1</sup> depending on support by the network provider

**Instructions for using the Manual**

The package of the *PBX* includes the following manuals:

- 1 installation and configuration manual for the service and
  - 1 operation instruction manual for the user.
  - 1 CAPI/TAPI manual (Fax, Internet, Data transfer)
- This manual describes in all details the use of the PBX.





















**Use of the Manual**

This manual sorts explanations according to certain question types. Supposing the telephone rings in the room next to you and you would like to take the call, the [chapter \*You like to react to an inbound Call\* on page 10](#) will surely help you. In order to get certain information quickly and carefully directed, the manual will offer you different helps and guide lines:

- The table of contents on [p. 3](#) gives you an idea of content and organization of the operating manual.
- The index on [p. 72](#) helps you to find certain text portions for a certain term.
- In the texts you will be referred to other chapters or pictures with the help of cross references.
- The headlines on each page remind you in which chapter you are at the present. On the left side of the pages the headlines of the actual chapter will be repeated. On the right side the headlines of the paragraph will be repeated.

**Symbols used in this Manual**







The symbols or pictograms displayed in the following table are used in this manual in order to show common procedures during telephoning and configuration or requesting certain functions via telephone (enquiry).

	Hang up the receiver.		Pick up the receiver.
	A telephone is ringing.		You are hearing a tone, described in the corresponding chapter in more detail.
	Put the receiver next to the telephone.		Make a call. If you start the call yourself, you will hear the ringing tone (ringback tone) for some time.
	The door bell is ringing.		Dial external numbers or numbers that are to be dialled via exchange line.
	Dial Short-Code Dialling number.		Dial one of your own external telephone numbers.
	Dial telephone number of the internal group.		Dial internal telephone number or subscriber's telephone number.
	Dial number of the door terminal.		Dial password, e.g. secret password: Default factory setting 1111, after entering the password correctly you hear an acknowledgement tone.
	Dial 2- to 6-digit project number.		Switch on/off function (1: switch on, 0: switch off).
	Dial number of the door bell key.		Dial time with 4-digits: 00-23 (hours), 00-59 (minutes).
	Dial number of the relay.		Dial number within the indicated range. (in this case numbers from 0000 to 9998).
	Press the hook key on the handset.		Press star key (cancels a programming or disconnects a Direct Exchange Line Telephone from the exchange line)
	Dial a fixed digit (e.g. 1).		Query with FLASH key (in case of DTMF telephone) or Query key or menu selection (in case of an ISDN telephone, see manual of this telephone). Ignore in case of a pulse dial telephone.
	Press hash key (e.g. at the end of a programming function, you will then hear an acknowledgement tone).		



If you find such a procedure described this way, execute the stated actions step by step from the left to the right. Symbols that are stated one under the other are at your disposal as an alternative. Depending on your functional goal, you can exchange these symbol against the symbol in the first row.

**Example A: Set Ringing Rhythm for internal Calls**







 corresponding phone    
   public password    
      
   1 x long

or

 3 x short





---

**Example B: Enquire Call Charge Sum**

 corresponding phone    
   public password    
     digital announcement of total charges, then acknowledgement tone





**Example for Programming:** You like to set the ringer rhythm “3 x short” on a telephone for internal calls. In the [chapter Configure Ringer Rhythm for internal Calls on page 39](#) you find the procedure as described under **Example A** and you have to take the following steps:

- ① Pick up the receiver of the corresponding telephone and wait until you hear the internal dial tone.

- ② Dial .
- ③ Dial the public password (Default factory settings: „2“, but may have up to 4-digits). If you have entered the password correctly, you will hear the acknowledgement tone (pulsating tone). If you hear the busy tone instead, you will have to hang up and try again.
- ④ Continue dialling with  .
- ⑤ Dial  for „3 x short“.
- ⑥ At the end you confirm with the  key. Now you hear the acknowledgement tone again as a sign of a proper programming. If you hear the busy tone instead, you made a mistake (e.g. changed the digits) and you will have to hang up and try again.

Now you can hang up if you do not like to do further settings. But as soon as you hear the acknowledgement tone you are able to make additional settings or enquiries. In this case the entry of the password is not needed, provided that it is the same password. If you like to make a setting with the secret password or without a password, you will absolutely have to hang up the receiver.

**Example for additional Programming:** Now you like to enquire how many charge units have already been used on this telephone. In the [chapter Enquire Call Charge Sum on page 32](#) you find the procedure as described in **Example B** and you have to do the following steps:



- ① If you did not hang up after the last setting and if you still hear the acknowledgement tone, you will have to drop the  and the public password and start with dialling   unconditional.
- ② Then you confirm with the  key. Now you hear some short tones with a pause after each digit. You hear e.g. for 210 units: 2 short tones, pause, 1 short tone, pause, 10 short tones. Then you hear the acknowledgement tone again.

## Differences using various Telephones

You can connect system telephones and ISDN telephones as well as analog telephones with pulse dialling or those with dual-tone multifrequency dialling (DTMF) to your PBX. Devices with dual-tone multifrequency dialling must have a FLASH key (also called signal key R). The ISDN devices (e.g. ISDN telephones, ISDN PC controllers) should be certified Euro-ISDN devices in order to guarantee a proper functionality.

There are some differences when using or programming them. Familiarize yourself - especially with ISDN telephones - with the use of your telephone (see manual of the telephone).



### Analog Telephones (Pulse Dial and DTMF)

If you are already in a conversation condition with another subscriber (internal or external), you will have to press the FLASH key (signal key, R-Key) in case of a DTMF telephone before you are dialling a digit e.g. for Call Forwarding (compare [chapter Connecting analog Devices on page 63](#)). In this manual the FLASH key is represented by the symbol . The FLASH key is not necessary in case of a pulse dial telephone. Therefore if you connected a pulse dial telephone to your PBX, ignore pressing the FLASH key in the descriptions. Besides this the pulse dial telephones have no  and no  keys or these keys have no function. As these keys are necessary for enquiries and settings (programming), an execution of these functions with a pulse dial telephone is **not possible!** If your telephone offers both dial modes, you will have to set it to DTMF mode by all means.

### Analog T-Net-Telephones

With some of the analog DTMF telephones some of the T-Net functions (e.g. Call Forwarding) are assigned to special menus or function keys. If you use such a telephone as an internal subscriber telephone, you will be able to use this comfortable operation also for some functions of the PBX. These functions are marked with the T-Net-arrow . If you find this advice and you like to use the T-Net functions of your telephone, please read the manual of your telephone. Please pay attention to the preceding „0“ (exchange line access digit) if you enter the telephone number. Instead of the „announcement of the public exchange“ you will hear the acknowledgement tone for a successful programming.

### ISDN Telephones

In order to be able to operate your ISDN telephone, you will have to get familiar with its functionality. Therefore it is necessary to read the manual of the telephone and to read the ISDN telephone help files of Auerswald provided that your telephone is listed there (available on the Auerswald CD and the Auerswald homepage). It is absolutely necessary to know with which key or with which menu a Query can be started (e.g. hold key or R-key). This function is required if you see the following function symbol  in the manual. In some of the functions you will have to rely on the menu/function keys of the telephone. „Conference“, „Alternation“, „Accept/refuse waiting Call“, „Finish Query“ and „finish a Query on busy target“ belong to these functions. Please pay attention to the ISDN advice arrow . The digits to be dialled for analog telephones have to be ignored in this case.

### System Telephones

The major portion of PBX functions can be handled with all connected telephones as described in this manual. With the system telephones COMfortel 1500/2500 and COMfort 1000/1200/2000 plus as well as smar-tel-i (only for COMmander Basic) the use is much more comfortable because the most important functions can be controlled via menu (see advice). This operation is described in the manual of the telephone. Some of the described PBX functions can only be used with the system telephones as stated in the description.

## You like to react to an inbound Call

The PBX is able to signal an inbound call in different ways, e.g. by a ringing telephone or by a knocking tone in the receiver of a busy telephone. If a telephone rings, you will often recognize where the call comes from. (For some of the ISDN telephones only „a long tone, pause etc.“ is possible.)

In case of an analog telephone the external call can be signalled with e.g. „a long tone, pause etc.“ and an internal call with „three short tones, pause etc.“ instead. The door bell ringing is determined by pressing the bell key.

**Pickup:** If you hear another internal telephone ringing, you will be able to take this call with your own telephone or with the telephone next to you. In this case you have to use the „Pickup“ function. To be able to do this you take the call to your telephone by dialling a sequence of digits.

**Takeover:** If your e.g. answering machine (or your modem) takes your call, you will be able to take it over with a function named „Takeover“.

You dial some digits on your telephone and then you will be connected to the caller. The answering machine gets the busy tone.

**Call Waiting Tone:** If you hear a tone that repeats itself again and again - the knocking tone - during a call, an additional caller is trying to reach you or you are getting a door or alarm call. The external subscriber hears the ringing tone.

In order to be able to talk to the person that knocked, you will have two possibilities. First: You finish the current call by hanging up. Then your telephone rings and you can take the call. Second: You start a second call by dialling a sequence of digits (Query call). Then the present calling partner is in the background. What will be possible in a Query call is to be learned in the chapter [chapter You have two Calls \(Query Call\) on page 19](#).

If you do not like to talk to the waiting caller, you are able to ignore the waiting call or to refuse it by dialling a sequence of digits. The waiting caller will hear the busy tone then (if no other telephones ring).

### Your Telephone rings



telephone rings



conversation

**Take an internal or external Call**

If this call is an initiated call back, you will immediately hear the ringing tone after picking up the receiver. This will signal to you that the other subscriber is currently being called.

### Other internal Telephones ring (Pickup)



another telephone



your telephone



internal dial tone



(for Direct Exchange Line Telephone only)



6 and internal calling number of the ringing telephone



conversation

**Take call for an individual telephone (Pickup)**

The Takeover function and Pickup use the same functional procedure. In order to avoid that you take calls away from other telephones in case of a Pickup, switch off „conversation may be taken over“ via configuration program for all telephones. The permission for a Takeover is only useful for answering machines.

On the system telephones COMfortel 1500/2500 or COMfort 1000/1200/2000 plus a Pickup may be performed with a configured key also.

You can only execute a pickup for an external call if the necessary call authorization mode was configured for your telephone with the configuration program of the PBX.

### An Answering Machine already accepted a Call (Takeover)



your telephone



internal dial tone



(for Direct Exchange Line Telephone only)



6 and internal telephone number of the answering machine with the call to be taken over.



taken over call

**Take over call from the answering machine**

In order to be able to execute this function the taking over of the call from the answering machine and for the corresponding subscriber must be activated with the configuration program COMset. Besides this there is no difference to the Pickup as described before.

On the system telephones COMfortel 1500/2500 or COMfort 1000/1200/2000 plus a Takeover may be performed with a configured key also.

### Call Waiting Tone in the Receiver



1. conversation



knocking tone



(ignore with pulse dial)



Query call (No. 2)

**Take over waiting caller to talk to him (start Query call)**

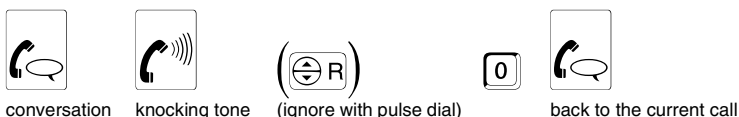

**Refuse waiting caller to continue the current call undisturbed**

If the waiting call is an Alarm call, the currently existing call will be terminated when accepting the waiting Alarm call. How to accept an alarm call is described on p. 22.

If you have already a Query call when it knocks, at least one of both calls has to be finished first.

If you have an analog telephone where you can execute the „take/refuse a waiting call“ function via T-Net function key/menu, you will be able to use this comfortable operation, too.

If you have an ISDN telephone or a system telephone the „take/refuse a waiting call“ function will be executed via an existing function key or via menu (e.g. with „take call“; see manual of the telephone).

**You like to make an internal Call**

Internal calls are free of charge.

**Internal Call Waiting:** If the internally called subscriber is busy you can generate Call Waiting signals on his telephone by waiting a short time (if Call Waiting is authorized for his telephone).

If your telephone is set as a Direct Exchange Line Telephone, you will hear the external dial tone right after picking up the receiver. Before you dial an internal telephone number, you have to

press the [\*]-key twice. Then you hear the internal dial tone. If the telephone has no [\*]-key or this key has another function, this function cannot be executed (pulse dial telephones and some ISDN telephones). On the system telephones COMfortel 1500/2500 and COMfort 1000/1200/2000 plus you press the key next to „internal“ instead, on the system telephone smar-tel-i (only on COMmander Basic) a key under „internal call“.

**Call an internal Telephone**

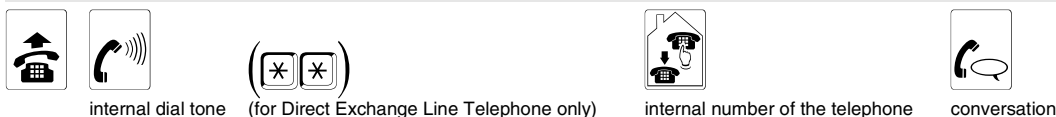

**Dial internal subscriber telephone number**

**Generate Call Waiting Signals on a busy internal Telephone**

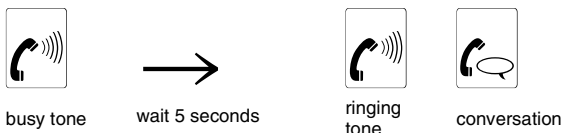

**Internal Call Waiting**

**You like to make an external Call (Call via Exchange Line)**

You have to dial an Exchange Line Access Number before you dial an external telephone number. If you make external calls most of the time and like to do that without dialling the Exchange Line Access Number, the telephone can be configured as a Direct Exchange Line Telephone (configuration program COMset).

**Short-Code Dial Number:** The external telephone numbers that you often use can be stored under a four digit Short-Code Dial Number to simplify the dialling. The entry of the telephone numbers is possible via PC software COMtools (p. 60) or via telephone (p. 34).

To save time in a case of emergency, you can assign the entries in the emergency Short-Code Dial memory to 2 or 3 digit numbers (10-59; 100-599), e.g. with the number 110 (via configuration software COMset). The dialling will happen as usual, the 4-digit Short-Code Dial Number (8...) will be replaced by the 2- or 3-digit number.

**Call without presentation of the calling number:** If you like to prevent that your next calling partner sees your telephone number on his telephone, you will be able to start an external call with the here stated digit

order. If you start an external call as described here, the presentation of your calling number to your calling partner will be restricted for this call.

If you like to start all the external calls without the telephone number transmission, you will be able to configure it for your telephone (see p. 24).

If your telephone is configured as a **Direct Exchange Line Telephone**, you hear the external dial tone right after picking up the receiver. In order to call an external connection, you have to dial the external telephone number **without** the Exchange Line Access Number [0]. In order to execute the other different call types, you have to dial each time the [\*]-key twice. If your telephone has no [\*]-key or if this key does not have the corresponding function, this function will not be usable (pulse dial telephones and some of the ISDN telephones). On the system telephones COMfortel 1500/2500 and COMfort 1000/1200/2000 plus you press the key next to „internal“ instead, on the system telephone smar-tel-i (only on COMmander Basic) a key under „internal call“.

**Call an external Number**

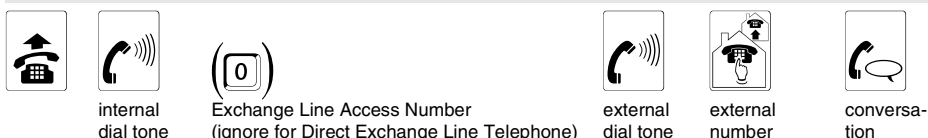

**Dial Exchange Line Access Number „0“ and external telephone number**

### Call an external Number via Short-Code Dial Number (Dialling Assistance)

internal dial tone (for Direct Exchange Line Telephone only) number of the Short-Code Dialling Number conversation

**Dial Short-Code Dial Number**

The PBX phonebook entries (number and name) are accessible from the phonebook menu of the system telephones COMfortel 1500/2500 and COMfort 1000/1200/2000 plus. A number presented by an inbound call matching an entry in this phonebook, will be represented by the name in the telephone display.

With the program *COMtools telephone book* you can transfer some of the short-code dialling numbers from the PBX into a connected system telephone COMfortel DECT 900 and COMfort DECT 800.

### Start external Calls without Presentation of your calling Number

internal dial tone (for Direct Exchange Line Telephone only) Exchange Line Access Number and external telephone number conversation

**Start individual calls without the transmission of the own telephone number**

You can use this function only if the ISDN service „Calling line identification restriction (CLIR)“ is available and activated by your network provider.

key or via menu. (see manual of the telephone; perhaps it is called as „deactivate the identification“ etc.).

For some of the ISDN telephones and for the system telephone COMfortel 1500/2500 and COMfort 1000/1200/2000 plus as well as smar-tel-i (only on COMmander Basic) you can activate the „Calling line identification restriction (CLIR)“ via an existing function

The T-Net digit sequence can be used: You can start the call with \*312 + 0 + calling number. If you use an analog telephone as an internal subscriber phone where a „call without presentation of the calling number“ can be started, you will be able to use also this comfortable operation (see manual of the telephone; perhaps it is called „call anonymous/nameless“).

## You like to separate the Charges of external Calls to different Accounts

In order to be able to assign the individual calls to certain accounts for call charge evaluation (e.g. with the PC program *COMlist*), the PBX offers you the following options:

**Present a special MSN:** To start external calls with the presentation of a special MSN, you need a system telephone COMfortel 1500/2500 or COMfort 1000/1200/2000 plus (see manual of a telephone).

**Selecting exchange lines:** If you like to get separate invoices for the charges of different external calls from your network provider, you can start these calls carefully directed via one of the existing S<sub>0</sub> ports (ISDN connection, exchange line).

Besides this you need this function e.g. if you connected a GSM gateway to an external S<sub>0</sub> port. A mobile phone call will be directed to this S<sub>0</sub> port then.

### Selecting Exchange Lines before starting an external Call (COMpact 4410 USB and COMmander Basic only)

internal dial tone (for Direct Exchange Line Telephone only) Exchange Line Access Number for the 1st to 4th S<sub>0</sub> port external dial tone external telephone number conversation

**Select the 1st to 4th exchange line before the call starts**

If you connected a GSM gateway or a Auerswald Box to an internal analog port you may select these ports for mobile phone or VoIP calls by dialling the internal number of these ports instead of the exchange line access number.

If your telephone is configured as a **Direct Exchange Line Telephone**, you hear the external dial tone right after picking up the receiver. In order to call an external connection, you have to dial the external telephone number **without** the Exchange Line Access Number . In order to execute the other different call types, you have to dial each time the \* -key twice. If your telephone has no \* -key or if this key does not have the corresponding function, this function will not be usable (pulse dial telephones and some of the ISDN telephones). On the system telephones COMfortel 1500/2500 and COMfort 1000/1200/2000 plus you press the key next to „internal“ instead, on the system telephone smar-tel-i (only on COMmander Basic) a key under „internal call“.

The prerequisite for such a selected exchange line access is that the PBX works with several ISDN exchange lines. If there are e.g. only two external S<sub>0</sub> ports, you will be able to use the Exchange Line Access Numbers and (COMpact 4410 USB: up to 2 S<sub>0</sub> ports after the extension with a COMpact 2S<sub>0</sub> module).

## The called Person does not take the Call

**Finish the Call in a Query:** If the called person does not take the call, you normally hang up. But if you do this out of an existing call while you are calling another subscriber for a Query or a Blind Transfer, you will

disconnect also the connection to the person waiting in the background. You dial the digit „1“ instead to finish the call here.

**Recall on no Reply:** If the called person does not take the call, you will be able to reach him without repeating the call by starting a recall in case of no Reply. The function is possible for internal as well as external calls. The necessary ISDN feature „Call Completion on No Reply (CCNR)“ will be supported by PBX.

If you have started a recall, you will be called by the public exchange/PBX as soon as the other subscriber hangs up after his next call. If you pick up the receiver then, the other subscriber will be called also by the public exchange/PBX. If the other one picks up the receiver too, a conversation will be established. Only then the recall is deleted.

### The called Subscriber in a Query does not take the Call – Finish the Call





**Stop Query call by dialling the digit „1“**

 For ISDN telephones and the system telephone the „Finishing a Query call“ will be executed via an existing function key or

via menu (e.g. with „End“, „Separate“, „Back“; see manual of the telephone).

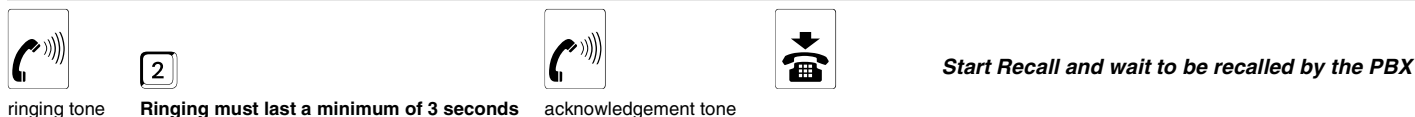
### Start a Recall on no Reply for internal Telephone Call



 You can start the recall in the menu of the system telephone COMfortel 1500/2500, COMfort 1000/1200/2000 plus and smar-tel-i (only on COMmander Basic; see manual of the telephone).

Some ISDN telephones do not support this function because it is not possible to dial while ringing.

### Start a Recall on no Reply for external Calls (CCNR).



 You can only use this function if the ISDN feature „recall on no reply (CCNR)“ is offered by the network provider and has been activated.

If you do not hear any confirmation tone, the recall request was refused by the public exchange.

You can start the recall in the menu of the system telephone COMfortel 1500/2500, COMfort 1000/1200/2000 plus and smar-tel-i (only on COMmander Basic; see manual of the telephone).

If you do not pick up the receiver in case of a recall in time (After you have been called for 15 seconds), the recall will also be cancelled.

Some ISDN telephones do not support this function because it is not possible to dial while ringing.

The technical condition for a recall must be given e.g. the recall to a PBX is not possible with some of the network providers.

A recall is tried up to 45 minutes by the public exchange. If the called person did not finish his call until then, the recall will be deleted automatically.

## You are Dialling a Number and are Hearing the busy Tone

**Recall on Busy:** If you hear a busy tone after dialling an internal or external telephone number, it can be the case that the called telephone is actually busy. If you want to reach the requested calling partner without repeated calling, you can start a Recall on Busy. The necessary ISDN feature „Call Completion on Busy Subscriber (CCBS)“ will be supported by PBX.

If you pick up the receiver during the ringing, you will hear the external dial tone as a sign of a reservation of the exchange line. Now you have to dial the external telephone number only and without Exchange Line Access Number.

If you have started a recall, you will be recalled by the public exchange/PBX as soon as the other subscriber finishes his current call. If you pick up the receiver then, the other subscriber will be called by the public exchange/PBX. If this one also picks up, a conversation will be established. Then the recall will be deleted in the public exchange/PBX.

**Priority Call:** If an internal telephone is busy for a longer period, it may be possible that the called person activated the Do-Not-Disturb service (no longer bothered by the telephone). If you have to reach this person nevertheless, you can override the Do-Not-Disturb protection of an internal telephone. If you hear the busy tone after dialling an internal subscriber number, and you like to reach the subscriber nevertheless, you will activate the Priority Call by dialling the digit „3“. If you are still hearing the busy tone, the other subscriber is currently telephoning.

**Reserve Exchange Line:** If you hear a busy tone right after the dialling of the Exchange Line Access Number, all the exchange lines (1st and 2nd B channel of the available external S<sub>0</sub> ports) are busy at the moment. Now you are able to reserve an exchange line by dialling the digit „2“.

 If you **always** hear the busy tone after the dialling of certain external telephone numbers or if it is even always the case right after dialling the Exchange Line Access Number, please check whether your telephone has the necessary calling authorization for dialling external telephone numbers (the setting of the exchange line authorization is made in the configuration program COMset). A busy tone after picking

If you have started an exchange line reservation as described here, you will be called by the PBX as soon as there is a free line.

up in case of an external ringing may also be a signal for a missing calling authorization.

If you **always** hear the busy tone after dialling a Short-Code Dialling number, this will point to a missing calling authorization mode or to a not programmed Short-Code Dial Number.

### Start Recall on Busy for internal Telephone Call



**Start Recall and wait to be recalled by the PBX**

On the system telephone COMfortel 1500/2500, COMfort 1000/1200/2000 plus and smar-tel-i (only on COMmander Basic) the „Recall on Busy“ is started via menu (see manual of the telephone).

Here you can use the T-Net digit sequence and you will be able to start the „Recall on Busy“ with  $\text{☎R} + \text{☎}37\text{#}$ . If you use

an analog telephone as an internal subscriber telephone and you can start a „Recall on Busy“ via T-Net function key/menu, you also will be able to use this comfortable operation (see manual of the telephone). Instead of an announcement of the public exchange you will hear the acknowledgement tone.

### Starting Recall on Busy via Public Exchange for external Connection (CCBS)

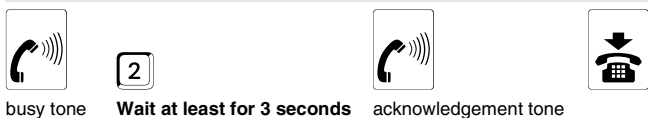

**Start Recall on the exchange line and wait to be recalled by the public exchange**

On the system telephone COMfortel 1500/2500, COMfort 1000/1200/2000 plus and smar-tel-i (only on COMmander Basic) the „Recall on Busy“ is started via menu (see manual of the telephone).

If you do not hear any confirmation tone, the recall request was refused by the public exchange.

The technical condition for a recall must be given e.g. the recall to a PBX is not possible with some of the network providers.

It may be possible that the public exchange starts the recall before the subscriber you have called has hanged up because one B channel of his ISDN connection is free.

A recall is tried up to 45 minutes by the public exchange. If the called person did not finish his call until then, the recall will be deleted automatically.

If you do not pick up the receiver in case of a recall in time (After you have been called for 30 seconds), the recall will also be cancelled.

Here you can also use the T-Net digit order and you can start the „Recall on Busy“ with  $\text{☎R} + \text{☎}37\text{#}$ . If you use an analog telephone as an internal subscriber telephone and you can start a „Recall on Busy“ via T-Net function key/menu, you will be able to use also this comfortable operation (see manual of the telephone). Instead of an announcement of the public exchange you will hear the acknowledgement tone.

### Reserve Exchange Line for the next Call on busy Exchange Lines



**Reserve exchange line and wait to be recalled by the PBX**

In case of an ISDN telephone direct dialling after taking the receiver of the ringing telephone is not possible (instead of the external dial tone you will hear the acknowledgement tone). Hang up the receiver and pick it up right after that - now you can dial again (with direct Exchange Line Access Number).

If you like to start the external call with a Short-Code Dial Number, you will have to release the exchange line first. Press the  $\text{☎}$  key twice. If the  $\text{☎}$ -key does not exist or does not work (is valid for pulse dial telephones and some of the ISDN telephones), you will have to hang up for at least one second before you dial the Short-Code Dial Number.

### Start a Priority Call to a Telephone protected by the Do-Not-Disturb Service

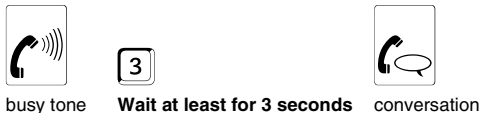

**On busy start Priority Call to override the Do-Not-Disturb protection**

### The Subscriber called in a Query is busy - Finishing the Call

If the called subscriber is busy, you normally hang up. But if you do it out of an existing call during you call another subscriber in a Query, you would also disconnect the connection to the waiting caller in the background. In case of analog telephones the calling will be finished by the PBX after some seconds. Then you will be reconnected to your first calling partner.

For the ISDN telephones and the system telephone the „Finish a Query“ function will be executed via an existing function key or via menu (e.g. with „end“, „separating“, „back“ or pressing of the R-key once more; see manual of the telephone).

## You are in a Conversation

During a call different situations may occur e.g. you like to ask another person to this conversation issue or another caller tries to reach you.

You are not forced to finish the current call to react to these circumstances, you will be able to put this call on hold in the PBX or to park it for a short time period.

**Query Call:** If you like to ask a question to somebody during a call without finishing the conversation, use the Query. The current conversation is put on Hold in order to call the other subscriber. The 1st calling partner is on Hold in the background in the PBX and listens to the Music on Hold.

In order to start a Query in case of DTMF telephones or ISDN telephones, you will have to press the FLASH key or R-key first (see [chapter Differences using various Telephones on page 9](#)). Then you will hear the internal dial tone as after picking up the receiver and you can start a call as usual.

**Pickup:** If you hear an internal telephone ringing, while you are just having a call, you are able to put the current call on hold by the PBX, in order to accept another call. For this purpose you use a function that is called „Pickup“. With this function you transfer the call to your telephone by dialling a sequence of digits.

**Muting a Call (with DTMF-Telephones):** If you like to make a call with a DTMF telephone it will be possible to interrupt it for a short period in order to ask a question into the room. Simply press the FLASH key. You will hear the internal dial tone then. Your calling partner is on hold in the background and listens to the Music on Hold during this time. In order to continue the call, press the FLASH key again.

**Parking external Call:** If you have an external call and like to interrupt it for a short time, you are able to park it with the function „Parking/Ter-

minal Portability“ up to 3 minutes in the public exchange. If you like to change the room during the parking, you are able to unpark the call with any other internal telephone again. The call has to be unparked within 3 minutes otherwise it will be disconnected by the public exchange and you will hear the busy tone while you are unparking.

You are also able to park or unpark the call with an ISDN device that you are using in parallel to the PBX on the same NT (see operation manual of the corresponding device). Some of these ISDN telephones are not able to takeover a parked call without a **parking code**. If you use such an ISDN telephone on a Point-to-Multipoint connection in parallel to the PBX, you can instruct the PBX via program function to park calls onto the bus always with a parking code (see [chapter You like to park Calls with a Parking Code on page 47](#)).

**Parking a Call on the internal S<sub>0</sub> Port:** If you have a conversation with an ISDN telephone (internal subscriber) on the internal S<sub>0</sub> port and like to interrupt it for a short moment, you will be able to park it on the internal S<sub>0</sub> port with the function „Parking/Terminal Portability“ up to 3 minutes. How to execute this function on your ISDN telephone is to be learned in the operation manual of the corresponding telephone. This function is often called **Parking/Terminal Portability (TP)**. A parking code number will be ignored by the PBX and is harmless.

If you like to change the room during the parking period, you will be able to pull out the ISDN telephone of the wall jack and put it into another wall jack of the same S<sub>0</sub> bus. The call has to be unparked by an ISDN telephone on the same internal S<sub>0</sub> bus within 3 minutes, otherwise it will be disconnected.

 The [chapter You have two Calls \(Query Call\) on page 19](#) describes the options for query calls.

How to accept/take/reject a waiting caller, can be learned in the [chapter Call Waiting Tone in the Receiver on page 10](#).

### Start second call (Query Call)



conversation  
(No. 1)



(ignore with  
pulse dial)



Exchange Line Access Number and external  
number



external Query call  
(No. 2)

or



Short-Code Dial Number

or



Exchange Line Access Number for the 1st to  
4th S<sub>0</sub> port and external telephone number

**Start external Query call**

**Start external Query call with Short-Code Dial  
Number**

**Start external Query call via 1st to 4th exchange  
line (COMPact 4410 USB and COMMANDer Basic  
only)**



conversation  
(No. 1)



(ignore with  
pulse dial)



internal number of a telephone



internal Query call  
(No. 2)

or



number of the door terminal

**Start internal Query call**

**Start internal query call to the door terminal (only  
possible with the door/switch module)**

 During a door terminal call a Query is not possible. In contrast to that, you are able to start a door terminal call from within another call.

On a **Direct Exchange Line Telephone** you hear the internal dial tone after pressing the FLASH or R-key. The operation in this case is the same like for the other telephones.





 On ISDN telephones and on the system telephone the „Query“ is started via an existing function key or via menu (e.g. with „Call2“, „Query“, „on hold“ or „R-key“; see manual of the telephone).

 If you use an analog telephone as an internal subscriber telephone, where you can start a „Query call“ via T-Net function





key/menu, you also will be able to use this comfortable operation (see manual of the telephone). If you are requested to enter the telephone number using the T-Net function, you will have to enter the Exchange

Line Access Number<sup>0</sup> in case of external calls. The PBX supports also internal or Short-Code Dial Numbers as telephone numbers.





### Other internal Telephones are ringing (Pickup if you are in another Call)

				<b>Take call for single telephone (Pickup)</b>
conversation (No. 1)	(ignore with pulse dial)	6 and internal number of the ringing telephone	Query call (No. 2)	

### Parking external Call on the external S<sub>0</sub> Port (For Point-to-Multipoint Connection only)

					<b><u>Park call in the public exchange</u></b>
external call via 1st. external S <sub>0</sub> port	(ignore with pulse dial)		acknowledgement tone		

					<b><u>Unpark a Call</u></b>
every internal telephone	internal dial tone	(for Direct Exchange Line Telephone only)		conversation	

 The acknowledgement tone during parking changes to the busy tone after approximately 3 seconds. That does not mean that the parking failed. If you hear the busy tone unconditional instead of the acknowledgement tone, the parking failed and you will be reconnected to your calling partner after some seconds. Perhaps in this case the service feature „Parking/Terminal Portability“ is not supported by your public exchange.

The function key „Parking/Terminal Portability“ of ISDN telephones on

the internal S<sub>0</sub> port is not usable here. This key will park the call on the internal S<sub>0</sub> port not on the external S<sub>0</sub> port.

COMpact 4410 USB and COMmander Basic: Only an external call made on the 1st external S<sub>0</sub> port can be parked (e.g. in order to take it over with an ISDN telephone that you are using in parallel to the PBX on the same NT). But the transfer is much more convenient for the hand-over to internal telephones (see [chapter You are in a Call and like to Transfer it on page 16](#)).

## You are in a Call and like to Transfer it

**Transfer Calls with preceding Announcement:** If you like to transfer a call to another calling partner, you will interrupt the current call for a Query to the other subscriber. The 1st calling partner is put on hold in the background in the PBX and listens to the Music on Hold. After talking to the second subscriber and announcing the person to be transferred, you simply hang up the receiver. Then both of your previous talking partners are connected with each other.

**Blind Transfer:** If you like to transfer an external call to another internal telephone, you will interrupt the existing call in order to call the internal subscriber. The 1st calling partner is put on hold in the background in the PBX during this time and listens to the Music on Hold. Instead of waiting for the 2nd connection, you can hang up the receiver during the calling. The internal telephone is called further on.

**Open Query:** If you like to transfer an external call to a yet unknown internal target (because you do not know the location of the requested person) you can use the „Open Query“. With this function you can transfer the external caller to a previously defined internal number first. The caller will be on Hold in the PBX (duration may be configured via configuration program *COMset* as duration of blind transfer) and hears the Music on Hold. Now you can search the requested person e.g. by an announcement and ask him to take the caller. The person can take the caller by a Pickup of the previously used number.

**Transfer to a 3rd calling partner:** Supposing that you took an additional call out of a call e.g. a waiting call (you are already connected to two subscribers) and this second calling partner likes to be connected to another person so you are able to start a third call. The 1st as well as the 2nd calling partner are put on hold on in the background.

 It may happen with some ISDN telephones that your telephone rings after hanging up and that you are reconnected to your 1st calling partner if you pick up the receiver. Please check the operation instructions of the telephone whether the „PBX Transfer“ is activated on. Please try to configure this problem, if necessary.

An external call can only be exchanged to an internal subscriber if the necessary call authorization mode was configured for this telephone with the configuration program of the PBX.



**Transfer a Call with prior Notice**



**Start external Query call and connect both calling partners by hanging up**

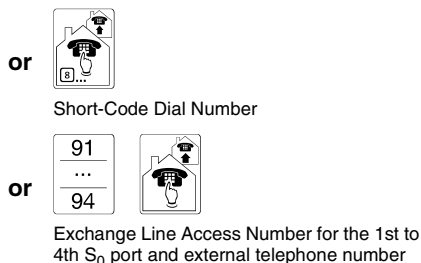

**Start external Query call with Short-Code dialling and connect both calling partners by hanging up**

**Start external Query call via 1st to 4th exchange line and connect both calling partners by hanging up (COMPact 4410 USB and COMmander Basic only)**



**Start internal Query call and connect both calling partners by hanging up**

**👉** You can only transfer an external call to another external calling partner this way if the necessary permission for exchange line to exchange line switching was configured for your telephone with the configuration program COMset (this does not apply to an external call made via an analog VoIP/GSM adapter).

A transferred call between external calling partners is limited to a period configured with the configuration program (this does not apply to an external call made via an analog VoIP/GSM adapter). This is for your

security because e.g. the unintentional transfer to the speaking-clock announcement and the weather forecast service would lead to a never ending call.

**ISDN** For some ISDN telephones the „Transfer“ can be executed via an existing function key or via menu instead of hanging up the receiver (see manual of the telephone; perhaps it is also called „ECT“ or „Transfer“).

**Transfer external Call without Announcement to an internal Telephone (Blind Transfer)**



**Start internal call and hang up to transfer an external call**

**👉** If the called subscriber does not pick up (the ringing duration may be configured for analog destination subscribers via configuration program COMset), the call will return to your own telephone after 60 seconds (your telephone rings). If you are not picking up this

call within 60 additional seconds the call will be disconnected. If your own telephone is busy in that moment, the procedure will be finished already after the first 60 seconds and the external call will be disconnected.

**Transfer an external Call to a currently unknown internal Target (Open Query)**

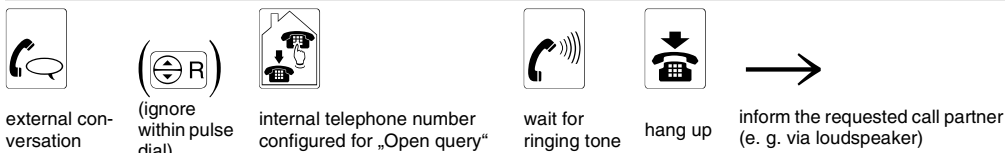

**Start Open Query and hang up to transfer the external call**

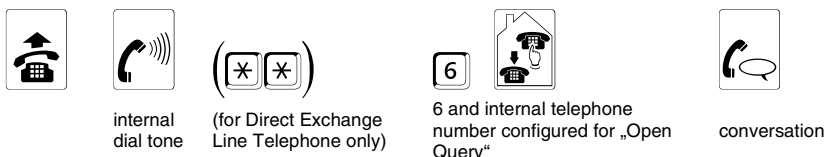

**Accept Open Query call with Pickup**

To perform the „Open query“, an internal telephone number has to be configured for an unused analog port. This way the connection of an analog telephone is not possible at this port. If two or more „Open Que-









ries“ have to be possible at the same time, more internal telephone numbers have to be configured.

If you hear the busy tone after dialling the internal telephone number, the telephone number is already in use for an „Open Query“. Use another configured telephone number for an „Open query“ - if it exists.

If the called subscriber does not take the call (ringing period may be configured via configuration program COMset as ringing period for Blind

Transfer) the call returns to your own telephone (your telephone rings). After another 60 seconds the unaccepted call will be disconnected. If your own telephone is busy in the meantime, the external call will also be disconnected.

**Transfer external Call to an external Connection (External to External Transfer)**









						<b>Start external Query call and connect both calling partners by hanging up</b>
1. external conversation	(ignore with pulse dial)	get permission for external transfer	Exchange Line Access Number and external number	external Query call (No. 2)	hang up	
			<b>or</b>		<b>Start external Query call with Short-Code Dial Number and connect both calling partners by hanging up</b>	
			<b>or</b>		<b>Start external Query call via 1st to 4th exchange line and connect both calling partners by hanging up (COMPact 4410 USB and COMmander Basic only)</b>	
						
				Exchange Line Access Number for the 1st to 4th S <sub>0</sub> port and external telephone number		

 If the authorization for the exchange line to exchange line switching was configured for your telephone with the configuration program of the PBX, you are able to do the external to external transfer like any other transfer with a previous announcement (see p. 17).



A transferred call between external calling partners is limited to a period configured with the configuration program (this does not apply to an external call made via an analog VoIP/GSM adapter). This is for your security because e.g. the unintentional transfer to the speaking-clock announcement and the weather forecast service would lead to a never ending call.

The network provider will charge you for the transferred call.

**Calling an internal third Calling partner and transfer to the second calling Partner**

								<b>Start internal Query call (no. 3) and transfer to the 2nd calling partner</b>
Query call (see ①)	(ignore with pulse dial)		internal number of a telephone	internal Query call (see ②)	(ignore with pulse dial)		conversation with the 1st call partner – 2nd and 3rd partner are connected (see ③)	

 In order to „call a 3rd calling partner and to transfer“ on ISDN telephones this function **must** be supported by function key or menu of the telephone (e.g. with „call3“ in case of the system telephone or „Further connections“ in case of Eurit 40 of Ascom; see manual of the telephone).

 If the 3rd calling partner is not ready to be transferred, you will return to the normal Query with .

If you do not dial  in the 3rd call but hang up, the 2nd and 3rd calling partner will also be connected. Then the 1st call will be signalled by the PBX like an external call. An internal call will be disconnected.

If the 3rd calling partner is busy, you will be able to put the 2nd calling partner into the Waiting Field with  (compare with p. 48).

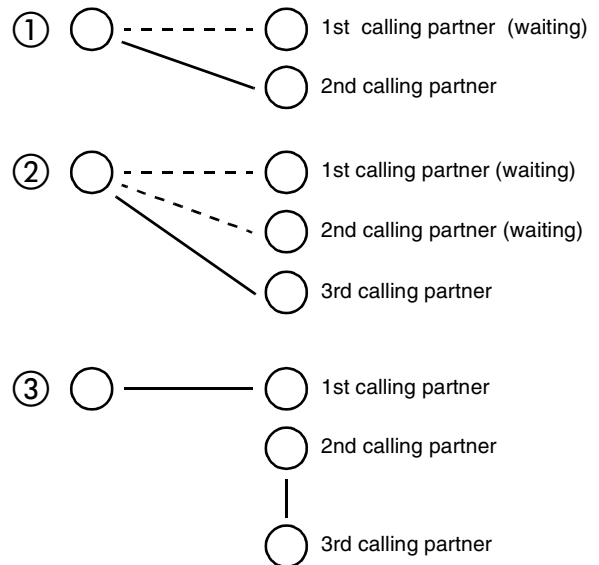

## You have two Calls (Query Call)

During a Query you are talking to a subscriber while your first calling partner is put on hold in the background in the PBX. and listens to the Music on Hold. A Query is started by calling a Query partner, by using the Pickup function during a call or by accepting a waiting call announced by the knocking tone.

**Transfer:** If you started a Query and like to connect the new calling partner with the calling partner on hold in the background, you can do this by simply hanging up the receiver.

**Finish one of both calls:** You finish a Query call by switching to the calling partner to be excluded from the conversation and finish the call with him.

**Alternation:** If you started a Query and like to talk to both calling partners alternately, you will be able to switch from one to the other by dialling a sequence of digits.

**Call Waiting Tone:** The knocking during a Query is **only possible with analog telephones**. If you like to talk to the waiting caller, you will have to finish at least one of both current calls in advance. If do not like to talk to the waiting call, you may just ignore the waiting call or refuse it by dialling a sequence of digits. This will be signalled by a busy tone to the waiting caller (if no other telephones is ringing at the same time).

**Conference:** If you started a Query and like to talk to both calling partners to simplify matters, you will be able to connect both calls to a Conference (three-party Conference call). In order to finish the Conference you can hang up the receiver and the connections will be completely disconnected then. If you like to continue the conversation with one of the calling partners or with both alternately, please read [chapter You have a Conference Call on page 20](#).

 If you hang up the receiver during a Query call, both calling partners will be connected with each other.

If one of both calling partners hangs up, you will be connected to the other one.

### Transfer both calling Partners



Query call (No. 2)



hang up

**Connect both calling partners by hanging up**

 You can only transfer an external call to another external calling partner this way if the necessary authorization was configured for your telephone with the configuration program COMset.

You cannot transfer a door call.

With some ISDN telephones it may occur that your telephone rings after hanging up and that you are reconnected to your 1st calling partner if

you pick up. Please check with the help of the manual of the telephone whether the „PBX Transfer“ is activated. Try to configure this option.

 With some ISDN telephones you can execute the „Transfer“ via an existing function key or menu instead of hanging up the receiver (see manual of the telephone; or also called „ECT“ or „hand-over“).

### Finish one of both Calls



Query call



(ignore with pulse dial)



switch calling partner (if necessary) (alternation)



call to be finished



(ignore with pulse dial)





finish this call



conversation with the caller on hold

**Change calling partner (if necessary) and finish active call**

 With ISDN telephones and the system telephone a Query is finished via an existing function key or via menu (e.g. with „separate“, „finish“ or „end“; see manual of the telephone).

 If you use an analog telephone as an internal subscriber telephone where the „finishing of the active connection“ is to be executed via T-Net function key/menu you can also use this comfortable operation (see manual of the telephone).

### Talking alternately with both Calling Partners (Alternation)



Query call (No. 2)



(ignore with pulse dial)



2



conversation (No. 1)



(ignore with pulse dial)



2



Query call (No. 2)

**Change from the Query call to the first call and switch back again**

 With ISDN telephones and the system telephone the „Alternation“ is executed via an existing function key or via menu (e.g. with „Alternation“, R-key“ or „call1/call2“; see manual of the telephone).

key/menu, you are also able to use this comfortable operation (see manual of the telephone).

 If you use an analog telephone as an internal subscriber telephone where the „Alternation“ is executed via T-Net function

 You do not need the support of the public exchange for the Alternation of two external calling partners. (ISDN service attribute „Alternation“ (HOLD)“ because the PBX supports the Alternation via the 2nd B channel.

### In the Receiver is a Knocking Tone - Reject the Waiting Caller



conversation



knocking tone



(ignore with pulse dial)



0



back to call

**Refuse the waiting Call**

### Talk to both Call Partners at the same Time (Conference)



**Start Conference call with both calling partners**

With ISDN telephones and the system telephone a „Conference“ is started with an existing function key or via menu (e.g. with „conf“, „Conference“ or „3-party Conference“; see manual of the telephone).

If you use an analog telephone as an internal subscriber telephone where you can set the „starting of a three-party Conference“ via T-Net function key/menu, you can also use this comfortable operation (see manual of the telephone).

You do not need the support of the public exchange (ISDN service attribute „Three-party Conference (3PTY)“) for a Conference of two external call partners because the PBX supports Conferences via the 2nd B channel.

A Conference is not possible with a door terminal.

If a handsfree operation telephone takes part in a three-party Conference internal subscribers, echo or whistle effects may occur.

### You have a Conference Call

During a Conference you are talking to two subscribers at the same time. If you started a Conference and like to finish this three-party call, the PABX will offer the following options:

**Transfer:** If you like to withdraw yourself from a self-initiated Conference and like to give your calling partners the opportunity of continuing their talk, you will be able to transfer them.

**Finish completely:** If you hang up the receiver during a Conference initiated by you, the call will completely be disconnected.

**Finish the Call with only one calling party:** If you finish a Conference and you like to continue talking to one of the both calling partners, you will be able to finish the call with the other calling partner selectively. For

this purpose it is necessary to know who was your 1st and who was your 2nd calling partner (before the Conference was started). If you are not totally sure and if you like to avoid finishing the wrong conversation, it will be safer to use the „Alternation“ and finish a call from this status.

**Alternation:** If you finish a Conference and like to talk alternately with both calling partners afterwards, you will be able to select one of the calling partners and put it on hold. For this purpose it is necessary to know who was the 1st and who was the 2nd calling partner (before the Conference was started).

Each of your calling partners is able to finish his participation in the Conference at any time by hanging up the receiver.

### Transfer both calling Partners



**Connect both Conference calling partners**

You can only transfer an external call to an additional external calling partner in such a manner if the necessary authorization was configured for your telephone with the configuration program of the PBX or if one of the calls was correspondingly established (p. 18).

In order to be able to „transfer (the calling partners) during a Conference“ this function **must** be supported via function key or via menu by the telephone (see manual of the telephone; perhaps also called as „ECT“ or „Transfer“).

### Finish the Call with only one calling Party

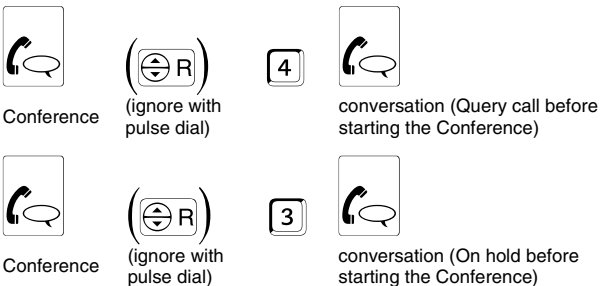

**Finish call with the 1st calling partner (was in the background before conference)**

**Finish call with the 2nd calling partner (was in a Query before conference)**

In order to „finish a Conference selectively“ this function must be supported via function key or via menu of ISDN telephones (e.g. with „separate“; see manual of the telephone).

### Talk alternately with both Calling Partners (Alternation)

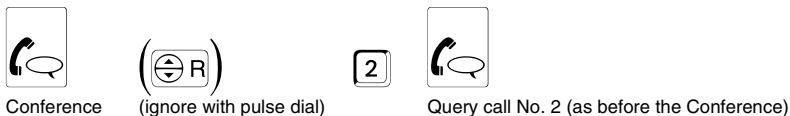

**Put 1st calling partner into the background (same condition as before Conference)**

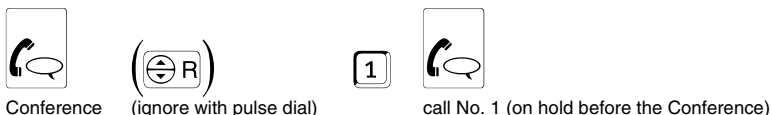

**Put 2nd calling partner into the background (before Conference in a Query call)**

**T-Net** If you use an analog telephone as an internal subscriber telephone where the „finishing of a Conference and back to Alternation“ is executed via T-Net function key/menu, you can also use this comfortable operation (see manual of the telephone).

**ISDN** In order to „finish a Conference selectively“ this function must be supported via function key or via menu by the ISDN telephones (e.g. with „Alternation“ or „single connection“; see manual of the telephone).

### Talking to a Visitor at the Door (Door Terminal Call)

If your PBX was extended with a door/switch module and a door terminal was connected, you will be able to call the door terminal via any telephone.

**The telephone rings:** If the „door ringing“ is activated on your telephone, the ringing of a visitor will be signalled on your telephone. Then you can take the door terminal call like any other call

**The door bell rings:** When you hear your door bell ringing, you are able to call the door terminal via any telephone. The connection is set right after having dialled the telephone number. If you are already in a call, start a Query.

**The visitor has not pressed the Door bell key:** When you hear your door bell ringing, you are able to call the door terminal via any telephone. The connection is set right after having dialled the telephone number.

**Open the door:** During a door call with a visitor in front of the door terminal you are able to activate the door opener by dialling a sequence of digits.

**Change to another door:** If you called one of both door terminals, but nobody takes the call, you are able to switch simply to the other door terminal by dialling a sequence of digits - if this door terminal is not busy. This is not a Query. The first door terminal is not put on hold in the background but available for calls.

### Your Telephone rings with the Door Bell Rhythm

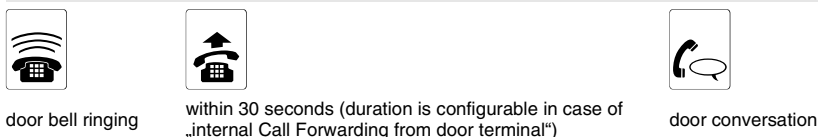

**Accept door terminal call**

**Hand icon:** With the „internal Call Forwarding from door terminal“ a bell rhythm for door terminal calls as well as the duration of the ringing can be configured with the configuration program. If the „internal Call Forwarding from door terminal“ for the corresponding telephone is switched off, this telephone will ring as long and as often as the visitor presses the door bell key.

The receiver has to be taken within 30 seconds (in case of „internal Call Forwarding from door terminal“ the duration is configurable in the con-

figuration program) after the last door bell ringing signal. If this is not the case, you have to call the door terminal (next chapter).

If the „door bell signalisation“ via configuration program is switched on, you will hear 1 to 4 short tones after picking up the receiver. This signals the origin of the call from the 1st to 4th door bell key (COMpact 4410 USB: The door keys on the module slot C have the numbers 3 and 4).

### The Door Bell rings







**Call door terminal**

**Hand icon:** If a telephone has been configured as door telephone with the configuration program **COMset**, you will be connected immediately with the door terminal after picking up the receiver.

### The Visitor has not pressed the Door Bell Key

					<b>Call door terminal</b>
internal dial tone	(for Direct Exchange Line Telephone only)	telephone number of the door terminal	door conversation		





### You are in a Conversation and the Door Bell rings

					<b>Start internal Query to call door terminal</b>
conversation (No. 1)	door bell rings	(ignore with pulse dial)	number of the door terminal	Query door conversation (No. 2)	

 On the system telephone COMfortel 1500/2500, COMfort 1000/1200/2000 plus and smar-tel-i (only on COMmander Basic) the door bell ringing is shown in the menu. By pressing the key under „door“, you can open the door menu without interrupting the conversation (see manual of the telephone).

If the „door ringing“ is switched on for your telephone and the Call-Waiting signal is allowed, a door call will knock during a call and you will be able to accept the waiting caller (see [chapter Call Waiting Tone in the Receiver on page 10](#)).





### Open the Door during a Door Call

					<b>Open the door</b>
door conversation	(ignore with pulse dial)		door opener activated, you will hear the acknowledgement tone for app. 2 sec	back to the door conversation	

 In the menu of the system telephone COMfortel 1500/2500, COMfort 1000/1200/2000 plus and smar-tel-i (only on COMmander Basic) „open“ is used to open the door (see manual of the telephone).

The telephone must have a permission configured by the configuration program COMset to be able to open the door.  
For some ISDN telephones the Query (or R) key must be pressed again after the 7 (maybe also „back“), in order to return to the door call.

### Change to another Door during a Door Call







				<b>Finish door terminal call and switch to the other door terminal</b>
door conversation	(ignore with pulse dial)		door conversation with the other door terminal, if not busy	

## You like to take an Emergency Call

If your PBX is extended with a door/switching module the door bell key inputs can be used as emergency inputs. An alarm may be signalled by the ringing of an internal telephone as well as of an external telephone. An alarm may be signalled by the ringing of an internal telephone as well as of an external telephone. In order to finish the whole alarm sequence, you are able to confirm the alarm as described here.



If you do not confirm the alarm (also if you dialled a wrong digit), you will hear the busy tone and the call will be automatically disconnected by the PBX. There may be another alarm call if the other alarm subscribers do not confirm the alarm either.



### Your Telephone rings with the Alarm Rhythm

						<b>Confirm alarm</b>
Alarm call to an internal (special ringing rhythm) or external telephone	announcement text (COMpact 4410 USB and COMmander Basic) Signal tone (COMpact 2206 USB)	within 60 seconds with DTMF telephone, DTMF sender or ISDN telephone with DTMF signalling	2 seconds confirming tone	confirm alarm		

 COMpact 4410 USB or COMmander Basic: After picking up the receiver an announcement text is played back that informs you about the reason of the alarm ([chapter Record the Alarm Announcement by Telephone and listen to it \(COMpact 4410 USB and COMmander Basic only\) on page 47](#)).

For the PBX COMpact 2206 USB no alarm announcement is possible. You hear a signal tone instead.

  The programming functions starting with „7“ and the public password (default is „2“) are available and changeable by each user on his telephone. Some of these functions can be used on T-Net telephones with T-Net functions keys or menus and are not password protected. The same is valid for functions controlled with function keys/menus on ISDN telephones.

  Some of the functions are protected with a secret password (default is „1111“) because they should only be changed by certain persons (e.g. the user of the PBX). The operation can be done on each internal telephone if not limited to a programming telephone with the configuration program *COMset*. In this case these functions can only be done on the programming telephone.

Please pay attention to the fact that some functions may be forbidden or restricted via configuration program *COMset* for your telephone like e.g. the Call Forwarding.

If your telephone is configured as Direct Exchange Line Telephone, you will have to press the -key twice (not possible with pulse dial and some ISDN telephones) and hear the internal dial tone before dialling the first digit. On the system telephones COMfortel 1500/2500 and COMfort 1000/1200/2000 plus you press the key next to „internal“ instead, on the system telephone smar-tel-i (only on COMmander Basic) the key under „internal calls“.

Further information about programming can be found in the [chapter Symbols used in this Manual on page 8](#) and [chapter Analog T-Net-Telephones on page 9](#).





## You like to use different PBX Configurations (Day, Night etc.)

The PBX makes it possible that some functions with the configuration program *COMset* are configured differently e.g. for day, night, holiday and lunch break. Up to six different configurations are available. This quantity may be restricted in the configuration program *COMset*. The switching over from one configuration to another one may be done time controlled corresponding to the internal clock of the PBX.







**Make Settings:** If the PBX works with several configurations, you will be able to make the settings configurable via telephone also configuration depending by informing the PBX in advance, for which configuration this setting will be valid. If you are not doing this, the setting will be valid for all configurations (default factory setting).

**Switching over by Hand:** If a corresponding authorization was set for your telephone with the configuration program *COMset*, you will be able to do manual configuration switch-over. This is also possible in addition to an already existing automatic switch-over setting.

**Automatic Configuration:** If switching times have been defined for different configurations with the configuration program *COMset*, you can activate or deactivate the automatic configuration switching with a telephone.

  The settings marked with the day/night arrow   are configuration dependent.

### Make Settings depending on switchable Configurations

       **Next setting will be valid for configuration 1...6.**















public password for configuration 1 to 6

or  **Next setting will be valid for all configuration.**

for all configurations

or  **Next setting will be valid for the active configuration.**







for the active configuration

 *Example: Supposing that the PBX works with two configurations e.g. the first configuration is active during the day and the second during the night. Perhaps you will not be available for the next two days and like to forward your telephone calls to your mobile phone. But at night the calls should be taken by an answering machine. So you dial first         for the „day configuration“ and then you activate a subscriber Call Forwarding to your mobile phone. After the acknowledgement tone you will dial      for the „night configuration“ and then you activate the subscriber Call Forwarding to the answering machine.*

If you made further settings without preceding configuration switch-over, these settings will continue to be valid for the „night configuration“. But if you are waiting longer than 2 minutes after hanging up, the following programming is valid for the all configurations again.

If you like to do a setting dependent on a configuration that needs the secret password, you should also use the secret password here to avoid hanging up in between settings. If functions have no password you have to hang up in between.

### Switching over the Configurations by Hand

       **Switch on configuration 1...6.**

public password configuration 1 to 6

 *On the system telephone COMfortel 1500/2500, COMfort 1000/1200/2000 plus and smar-tel-i (only on COMmander Basic) the configurations can be switched over comfortably via menu and be enquired (see manual of the telephone)*

*The quantity of possible configurations can be restricted in the configuration program *COMset*.*

*If the automatic configuration switching is activated at the same time, the configuration activated here is valid until the next switching time has been reached.*

### Activate automatic Configuration Switching



secret password

1: on, 0: off

Switch on or off the time controlled switching over of the configurations

After a power failure the time information is lost. In this case automatic switching and the Wake-up function will not be performed. After adjusting the time by the programming sequence on p. 47

or by an outbound external call the functions will be active again (you can configure in COMset an automatic call to a number e.g. it's own number for this purpose).

### Enquire the active Configuration



public password

1-6 tones: configuration 1-6

Enquire the active Configuration

## You like to stay reachable during your Calls

**Permit/Forbid the Call Waiting:** If you permit the „Call Waiting“ for your telephone, you will be able to continue your current calls even without nervous waiting for an important call (also door- and alarm calls are knocking). Also while you are just having another call, the calling party hears the ringing tone (internal caller after 5 seconds only). Then you will hear the so called „knocking tone“. This signals you that somebody tries to reach you. You will have the option to refuse the waiting caller -

he will hear the busy tone then - or you accept the call and your previous calling partner waits in the background (see [chapter Call Waiting Tone in the Receiver](#) on page 10).

**Forward Calls:** Additionally you can [Forward Telephone „on Busy“ to an internal/external Telephone because you are currently Telephoning;](#) p. 26.

### Permit/Forbid the Call Waiting (Knocking) for the Telephone

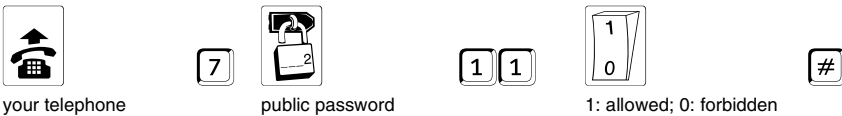

your telephone

public password

1: allowed; 0: forbidden

Permit or forbid knocking (Call Waiting)

On some of the ISDN telephones the Call Waiting will have to be permitted additionally for the telephone itself (see manual of the telephone).

The knocking of emergency calls cannot be forbidden.

Here the T-Net digit order can also be used that means that you are able to permit the „Call Waiting“ with \*433# and to

forbid it with #433#. If you use an analog telephone as an internal subscriber telephone, where the „Call Waiting“ can be permitted/forbidden via T-Net function key/menu, you are also able to use this comfortable operation (see manual of the telephone). You will hear the acknowledgement tone instead of the announcement of the public exchange.

## You do not like to present your Telephone Number to the Called Party

**Restrict the outbound number presentation for all off your outbound calls:** If you like to start all external calls without the calling number presentation, you can configure it for your telephone.

**Restrict the outbound number presentation for the next outbound call:** If you do not like to present your telephone number to your next calling partner (to see it on his display), you can start an external call without telephone number presentation (see [chapter Start external Calls without Presentation of your calling Number](#) on page 12).

### Restrict the calling Number Presentation for all of your outbound Calls



your telephone

public password

1: always restricted,  
0: not restricted

Switch on or off the calling number presentation

You can only use this function if the ISDN service attribute „Calling Line Identification Restriction (CLIR)“ was activated and is supported by your network provider.



## Somebody should be reachable for internal/external Callers to your Telephone Number (Subscriber Call Forwarding)

Thanks to the subscriber Call Forwarding (CF) you are able to forward internal and external calls that are targeted to your telephone to other internal telephones or external connections. You or your corresponding substitution can take these calls on another telephone.

So the subscriber Call Forwarding enables you or your corresponding substitution to be always available under your telephone number even if you cannot take a call on your original telephone.

As there may be different reasons for not being able to take a call e.g. you are absent for a shorter or longer period or you are just talking on your telephone, there are three different kind of Call Forwarding: „the immediate subscriber Call Forwarding“, the „subscriber Call Forwarding on busy“ and „subscriber Call Forwarding on no Reply“.

**Forward telephone „unconditional“:** If you abandon your telephone for a longer period (e.g. you start off on your holidays) and like to avoid that the telephone always rings in vain, you are able to forward the calls to the telephone of your substitute (e.g. to the your colleague or to the answering machine). Or if it is possible to take the calls on another telephone e.g. your mobile phone, you will able to forward them also to an external connection.

**Forward telephone „on Busy“:** If you are often busy and having long calls and like to save other callers from long waiting time, you can activate the „subscriber Call Forwarding on busy“. Then inbound calls are forwarded to another telephone (e.g. to one of your colleagues or to the answering machine) if your telephone is busy at the moment.

**Forward telephone „on no Reply“:** If you like to be sure that somebody takes your calls even if you leave the room for a short moment, you will reach this by switching on the „subscriber Call Forwarding on no Reply“. If you do not take the call within 20 seconds (configurable), the call will be forwarded to another telephone (e.g. of your colleague).

**Switch off all:** If you are not totally sure which kind of subscriber Call Forwarding is actually switched on, and like to make sure that each one is switched off, you will achieve it with this programming.

**Follow-me:** In case that you have already left your telephone and like to configure a forwarding, you can use Follow-me. It has the same function like the „subscriber Call Forwarding“ to an internal telephone as

described in the previous chapter, only that it can be configured on the corresponding destination telephone (instead of the telephone to be forwarded). So you are able to go from room to room and take your calls with you.

**Programming via an external telephone:** In case that you have already left your house and like to configure a forwarding, the subscriber Call Forwarding is also programmable via an external telephone. You are in need of an analog DTMF telephone, an ISDN telephone with DTMF signalling or a DTMF sender. Besides this the PBX has to be configured correspondingly with the configuration program COMset.

 For each of the three Call Forwarding options a different destination can be configured.

If the „CF on busy“ and „CF on no Reply“ are activated at the same time, both variants will be in use. Depending on the case - the telephone is busy or nobody takes the call - the call will be forwarded perhaps even to different destination numbers.

If an „CF unconditional“ is activated in addition to a „CF on busy“ and/or a „CF on no Reply“, only the „CF unconditional“ is used that means the whole calls will be forwarded to the destination of the „CF unconditional“. In this case the other forwarding settings are ignored, but are still active in the background. As soon as the „CF unconditional“ is switched off, the other still active forwarding settings are used again.











Also if you switched on an CF on your telephone, you are able to start further calls. If you pick up the receiver you will hear a special dial tone instead of the usual internal dial tone.

A Call Forwarding authorization to external numbers for your telephone has to be configured with the configuration program COMset.

If you set an internal telephone as forwarding destination, this one will need to have at least the partial exchange line access for forwarded external calls.

Do not mix up the subscriber Call Forwarding and the MSN/DDI Call Forwarding. You can only forward external calls to your mobile phone or another external connection with an MSN/DDI Call Forwarding. A forwarding of internal calls or to internal calls is not possible. So if you like to prevent that internal calls are forwarded to your mobile phone, use the MSN/DDI Call Forwarding (see p. 28).

### Forward Telephone „unconditional“ to an internal/external Telephone because you are absent

								<b>Switch on Call Forwarding with entry of an internal subscriber number as destination</b>
your telephone		public password	„CF unconditional“ (for „CF on busy“ 13 instead of 12 and for „CF on no Reply“ 14 instead of 12)			internal number of the target telephone		
	or							<b>Switch on Call Forwarding with entry of an external number as destination</b>
		Exchange Line Access Number and external number of the target telephone						
	or							<b>Switch on Call Forwarding with entry of a Short-Code Dial Number as destination</b>
		Short-Code Dial Number						

 If this kind of subscriber Call Forwarding always has the same destination telephone number, you have to configure the destination calling number only once. Afterwards the Call Forwarding is just switched on or off.

 On some ISDN telephones and on the system telephone COMfortel 1500/2500, COMfort 1000/1200/2000 plus and

smar-tel-i (only on COMmmander Basic) you can switch on/off the „subscriber Call Forwarding“ also via an existing function key or menu (see manual of the telephone; it is also called „call diversion“). If you are asked to enter the destination number when using the function key or menu, you will have to enter the Exchange Line Access Number  in

case of external telephone numbers. On the PBX you can also enter internal or Short-Code Dial Numbers as destination telephone numbers.

 Here you can also use the T-Net digit order that means you are able to switch on the „Call Forwarding unconditional“ with \*21\* + telephone number + # and switch off with #21# („on busy“ 67 instead of 21; „no Reply“ 61 instead of 21).

If you use an analog telephone as an internal subscriber telephone where the „Call Forwarding“ is to be switched on/off via T-Net function

key/menu, you will also be able to use this comfortable operation (see manual of the telephone). Then you will hear the acknowledgement tone instead of the public exchange announcement.

If you are asked to enter the destination number when using the T-Net function, you will have to enter the Exchange Line Access Number<sup>0</sup> in case of external numbers. You can also enter destination numbers as internal or Short-Code Dial Numbers.

 These settings are configuration dependent.

**Forward Telephone „on Busy“ to an internal/external Telephone because you are currently Telephoning**

The „Forward telephone on Busy“ is configured similarly as described for the „CF unconditional“ above. The digits 12 only have to be







exchanged for 13 in order to switch on/off a „CF on busy“ instead of an „CF unconditional“.

**Forward Telephone „on no Reply“ to an internal/external Telephone in Case of a short Absence**

The „Forward telephone on no Reply“ is configured similarly as described for the „CF unconditional“ previously. The digits 12 only

have to be exchanged for 14 in order to switch on/off an „CF on no Reply“ instead of an „CF unconditional“.

**Switch the already configured Subscriber Call Forwarding on/off**

       **Switch on Call Forwarding without entry of a telephone number because number has already been saved**

your telephone      public password      „CF unconditional“  
(for „CF on busy“ 13 instead of 12 and for „CF on no Reply“ 14 instead of 12)

or  **Switch off subscriber Call Forwarding**







**Switch off all active Subscriber Forwarding Settings for the Telephone**

      **Switch off all subscriber Call Forwarding settings for the telephone**







corresponding telephone      public password

 These settings are configuration dependent.

**Receive Calls at another internal Telephone (Follow-me)**

       **Switch on Follow-me on the destination telephone**

target telephone      public password      internal number of the telephone to be forwarded

       **Switch off Follow-me on the destination telephone**

target telephone      public password

 These settings are configuration dependent.

 **Attention!** If you configure Follow-me for a telephone, a previously configured subscriber Call Forwarding for this telephone will be switched off. If you switch off Follow-me on a phone, all the subscriber Call Forwarding „unconditional“ settings that have this telephone as the destination, will be switched off.

The destination telephone needs to have at least the partial exchange line authorization for forwarded external calls.



You also can switch off the Follow-me from the forwarded telephone with 7 + password + 120# or with # 21#.

Thanks to Follow-me you can also forward the calls of several subscribers to a single telephone next to you.



**Programming Subscriber Call Forwarding via an external Telephone if you are „Out of Office“**

					
external telephone	remote switching and programming MSN/DDI	tone (1 sec)	continue with DTMF	external password	external acknowledgement tone (1 sec continuous tone)

**Start external Programming**

„CF unconditional“  
(for „CF on busy“ 13 instead of 12 and for „CF on no Reply“ 14 instead of 12)



  

internal number of the target telephone

star and internal number of the telephone to be forwarded

external acknowledgement tone (1 sec continuous tone)

**Switch on subscriber Call Forwarding with entry of an internal subscriber telephone number as destination**

or  





Exchange Line Access Number and external number of the target telephone

**Switch on subscriber Call Forwarding with entry of an external telephone number as destination**

or 

Short-Code Dial Number of the target telephone

**Switch on subscriber Call Forwarding with entry of a Short-Code Dial Number as destination**





   

„CF unconditional“  
(for „CF on busy“ 13 instead of 12 and for „CF on no Reply“ 14 instead of 12)

star and internal number of the telephone to be forwarded

external acknowledgement tone (1 sec continuous tone)

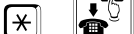
**Switch on subscriber Call Forwarding without entry of a telephone number because number has already been saved**



   

„CF unconditional“  
(for „CF on busy“ 13 instead of 12 and for „CF on no Reply“ 14 instead of 12)

star and internal number of the telephone to be forwarded

external acknowledgement tone (1 sec continuous tone)

**Switch off subscriber Call Forwarding**

internal number of the forwarded telephone

external acknowledgement tone (1 sec continuous tone)

**Switch off all active subscriber Call Forwarding settings for this phone**

 You are in need of an analog DTMF telephone, an ISDN telephone with DTMF signalling or a DTMF sender.

The PBX has to be configured correspondingly with the configuration program COMset.

You must have knowledge of the remote switching and programming MSN/DDI and the external password programmed with the configuration program COMset.

If you have started the programming as described here by calling the PBX and enter the correct external password, you will hear the external

acknowledgement tone. Then you can configure all the subscriber Call Forwarding settings. After successful programming you will hear the external acknowledgement tone again and may hang up or make further setting.

If you are waiting too long with the code input or enter a wrong code, you will hear a busy tone. In this case please hang up the receiver and try again.

## External Callers should always reach Somebody when calling your external Number (MSN/DDI Call Forwarding)

If you like to be reachable always for external calls even if you are not at home at the moment and if nobody can take the call on the internal telephones, use the MSN/DDI Call Forwarding.

Thanks to the MSN/DDI Call Forwarding you are able to forward an (exchange line) telephone number (dialled by an external caller) to another external telephone number. So these calls can be taken on another telephone, e.g. a mobile phone, if nobody takes the call internally.

As there may be different reasons for not taking a call, e.g. nobody is there during a shorter or longer period or all the internal telephones reachable under the same external number are busy, we have three different Call Forwarding settings: The „CF unconditional“, the „CF on busy“ and the „CF on no Reply“.

**Forward exchange line number „unconditional“:** If you leave the office and you are sure that the other persons reachable under this same telephone number have also already left, you are able to switch on the „MSN/DDI Call Forwarding unconditional“. Thanks to that you can forward your exchange line number (which an external caller dials) e.g. to your mobile phone. **The internal telephones do not ring at all if the forwarded number is called!**

**Forward exchange line number „on Busy“:** With an activated „MSN/DDI Call Forwarding on busy“ a forwarding to an external telephone will only happen if all internal telephones reachable under this exchange line number are busy. This includes your own telephone.

**Forward exchange line number „on no Reply“:** If you often commute between office and your customers and do not like to switch on/off the Call Forwarding each time, you will be able to forward your exchange line telephone number (that is dialled by an external caller) e.g. to your mobile phone as a precaution. Then the internal telephones will only ring 20 seconds (configurable) if somebody calls you. If no telephone is picked up within this time, your mobile phone will start to ring.

For each of the three types of Call Forwarding can be configured another forwarding destination.

If the „CF on busy“ and the „CF on no Reply“ are active at the same time, both variants will work. Depending on which case will occur - it is busy or nobody takes the call - the call will be forwarded and even to different destination calling numbers.

If an „CF unconditional“ is additionally activated to an „CF on busy“ and/or an „CF on no Reply“ only the „CF unconditional“ will work that means all the calls will be forwarded to the forwarding destination of the „CF unconditional“. The other variants will be ignored, but they are still switched on. As soon as the „CF unconditional“ is switched off, the other variants that are still switched on, are active again.

**Switch off all:** If you are not totally sure which kind of MSN/DDI Call Forwarding you have actually switched on and like to make sure that all of them are switched off, use this programming.

**Programming via an external telephone:** In case that you have already left your house and like to configure a forwarding, the subscriber Call Forwarding is also programmable via an external telephone. You are in need of an analog DTMF telephone, an ISDN telephone with DTMF signalling or a DTMF sender. Besides this the PBX has to be configured correspondingly with the configuration program COMset.











 An authorization has to be set for MSN/DDI Call Forwarding for your telephone with the configuration program COMset.

*If you like to divert calls to a T-Net box, the MSN/DDI Call Forwarding settings must be executed in the public exchange.*





*In the default factory settings the MSN/DDI Call Forwarding is not executed via the public exchange but via 2nd B channel of the PBX. If this setting was changed with the configuration program COMset, you will have to wait a little bit longer for the acknowledgement tone as usual because the CF was programmed in the public exchange.*

*Do not mix up the MSN/DDI Call Forwarding with the subscriber Call Forwarding. You can use this variant if you also like to forward internal calls. In this case a forwarding to internal telephones is also possible, e.g. to a colleague's telephone or to the answering machine (see p. 25).*





### Forward Exchange Line Number „unconditional“ to an external Telephone because nobody is there

									<b>Switch on MSN/DDI Call Forwarding with entry of an external number as destination</b>
public password		„CF unconditional“ (for „CF on busy“: 13 instead of 12, „CF on no Reply“: 14 instead of 12)				Exchange Line Access Number and external number of the target telephone	2-times star and your <b>own</b> external number to be forwarded (without area code)		
					or				<b>Switch on MSN/DDI Call Forwarding with entry of a Short-Code Dial Number as destination</b>
						Short-Code Dial Number of the target telephone (private are not possible)			

### Forward Exchange Line Number „on Busy“ to an external Telephone if the internal Telephones are busy at the Moment

How to switch on/off the „MSN/DDI Call Forwarding on busy“ can be learned above. The digits  have to be exchanged with , in order to switch on/off an „CF on busy“ instead of an „CF unconditional“.

### Forward an Exchange Line Telephone Number „on no Reply“ in Case of a short Absence

How to switch on/off the „MSN/DDI Call Forwarding on no Reply“ can be learned above. The digits  have simply to be exchanged with  in order to switch on/off an „CF on no Reply“ instead of an „CF unconditional“.

**Switch the already configured MSN/DDI Call Forwarding on/off for an Exchange Line Telephone Number**

public password „CF unconditional“ (for „CF on busy“: 13 instead of 12, „CF on no Reply“: 14 instead of 12) 2-times star and your **own** external number to be forwarded (without area code) #

**Switch on MSN/DDI Call Forwarding without entry of telephone number because number has already been saved**

or **Switch off MSN/DDI Call Forwarding**

**Switch off all active MSN/DDI Call Forwarding Settings for one Exchange Line Number**

public password **your own forwarded exchange line number** (without area code) #

**Switch off all active MSN/DDI Call Forwarding settings for a Telephone Number**

**Program MSN/DDI Call Forwarding from an external Telephone if you are „Out of Office“**

external telephone remote switching and programming MSN/DDI tone (1 sec) continue with DTMF external password external acknowledgement tone (1 sec continuous tone)

**Start external Programming**

„CF unconditional“ (for „CF on busy“ 13 instead of 12 or for „CF on no Reply“ 14 instead of 12) Exchange Line Access Number and external number of the target telephone 2x star and **own** external number to be forwarded (without area code) external acknowledgement tone (1 sec continuous tone)

or public Short-Code number of the target telephone (private are not possible)

**Switch on MSN/DDI Call Forwarding with entry of an external telephone number as destination**

**Switch on MSN/DDI Call Forwarding with entry of a Short-Code Dial Number as destination**

„CF unconditional“ (for „CF on busy“ 13 instead of 12 or for „CF on no Reply“ 14 instead of 12) 2x star and **own** external number to be forwarded (without area code) external acknowledgement tone (1 sec continuous tone)

**Switch on MSN/DDI Call Forwarding without entry of a telephone number because the number has already been saved**

„CF unconditional“ (for „CF on busy“ 13 instead of 12 or for „CF on no Reply“ 14 instead of 12) 2x star and **own** external number to be forwarded (without area code) external acknowledgement tone (1 sec continuous tone)

**Switch off MSN/DDI Call Forwarding**

**own forwarded** external number (without area code) external acknowledgement tone (1 sec continuous tone)

**Switch off all active MSN/DDI Call Forwarding settings for a telephone Number**

 You are in need of an analog DTMF telephone, an ISDN telephone with DTMF signalling or a DTMF sender.

The PBX needs to be configured for this operation with the configuration software COMset.

You need to know the remote switching and programming MSN/DDI and the external password that has been configured with COMset.

After starting the programming by calling the PBX and entering the external password, you will hear the external acknowledgement tone. You will now be able to configure an MSN/DDI Call Forwarding. If the programming was successful, you will hear the external acknowledge-

ment tone again. Now you can hang up the receiver or configure additional settings.

If you failed to enter the sequence in time or entered the wrong sequence, you will hear a busy tone. In this case hang up the receiver and start again.

If you entered by mistake the number to be forwarded with too many digits, you will hear an alternating high and low tone (negative acknowledgement tone). You will be able to start again from this situation - after this tone - unconditional.

## You do not like to be called

**Do-Not-Disturb:** If you temporarily do not like to be disturbed by your telephone, you can configure your telephone to prevent external and internal calls. A caller will hear the busy tone, an internal subscriber will be able to reach you in case of an emergency with a Priority Call. You are able to make calls from a telephone with Do-Not-Disturb function enabled.

**VIP List:** If you like to be reachable for certain persons with the activated „Do-Not-Disturb“, it will be possible to enter their external tele-

phone number into a VIP list with the PC software *COMtools* (see also p. 60). This VIP list is valid for all subscribers and you are able to activate or deactivate it for your telephone if necessary.

**Robinson List:** If you do not like to be called by certain persons, you are able to enter their external telephone numbers into the Robinson list with the PC software *COMtools* (see also p. 60). This Robinson list is valid for all subscribers and you are able to activate or to deactivate it for your telephone if necessary.

### Do-Not-Disturb Service for internal and external Calls

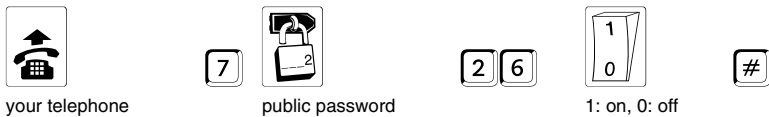

**Switch on or off the Do-not-Disturb function**

 You can configure the Do-Not-Disturb service in the menu of the system telephone COMfortel 1500/2500, COMfort 1000/1200/

2000 plus and smar-tel-i (only on COMmander Basic; see manual of the telephone).

### Deactivate Do-Not-Disturb for special Persons for external Calls (VIP List)

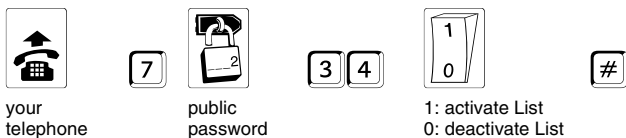

**De/Activate the VIP list**

 You can activate the VIP List in the menu of the system telephone COMfortel 1500/2500 and COMfort 1000/1200/2000 plus (see manual of the telephone).

The presentation of the caller telephone number is necessary for the PBX to recognize the caller.

### Prevent to be called from certain Individuals (Robinson List)

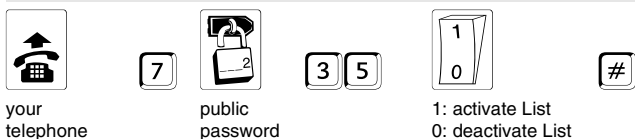

**De/Activate the Robinson list**

 You can activate the Robinson List in the menu of the system telephone COMfortel 1500/2500 and COMfort 1000/1200/2000 plus (see manual of the telephone).

The presentation of the caller telephone number is necessary for the PBX to recognize the caller.

## You like to save Call Charges with Least Cost Routing (LCR)

The PBX enables you to call easy and without prior thinking via the cheapest available network provider. This is called automatic Least Cost Routing.

With LCR the PBX selects the corresponding prefix telephone number of the provider proposed for the corresponding time for each external call you start and dials it first.







Example: You call a business partner on a Monday at 11:00 clock. The number is 0 53 06 / 92 00 - 700. The PBX identifies the area code as a local call. This time e.g. AT&T (0 10 10) has the cheapest rates for you on a Monday morning at 11:00 clock. You have properly configured the provider code, the time and area code for this local zone in the table. The PBX will now dial the provider code first and then the dialled number. The complete number dialled by the PBX is: 0 10 10 - 0 53 06 / 92 00-700.

To activate LCR on the PBX, the function has to be configured and the current tariff structure of the network providers has to be entered and stored.

**Switch on/off LCR with the telephone:** In the configuration program *COMset* or with the programming described here you can configure for each individual telephone whether it should use the services of the LCR program or not. If you switch on the automatic LCR with your telephone, the PBX will search the corresponding prefix telephone number of the provider proposed for the corresponding time for each external call you start and it will automatically dial it first.

 Please note that some providers do not transmit the charge information. If such a provider is used for a call, e.g. a call charge allowance will work for the corresponding call. To avoid this, the corresponding provider numbers should be entered as Blocking numbers with *COMtools* and activated for each telephone via *COMset*.

### Activate external Call Routing via several Network Providers (Automatic Least Cost Routing)

 your telephone   
    
  public password   
    
  1: on, 0: off   
 

Switch on or off the automatic Least Cost Routing

## You like to control Call Charges

**Configure Call Allowance:** If you like to have a fixed limit for call charges, you can configure a defined amount of charge units for each subscriber.

Once these charge units are spent, no external call is possible from this telephone until the Call Allowance is refilled or redefined.

The Call Allowance is set to 9999 (unlimited) in the default factory settings. If you like to limit the Call Allowance and make it work, you have to configure a value between 0000 and 9998. You can configure a new value or increase the value between 0000 and 9998 from time to time, to transfer the saved units to the future. The sum of units can never exceed the value of 9998.

These settings can also be entered with the program *COMtools Call Allowance* see p. 60).

You can configure with *COMset* if the Call Allowance accounts are charged for all calls, private calls, business calls, group calls (calls made as group member logged in outbound). Business and private calls are charged in the default factory settings.

**Control charge sum:** To control the call charges for each single subscriber, the call charges are also registered for each subscriber (view and delete the Call Allowance with the PC program *COMtools*; see p. 60). If you perform the enquiry and deletion regularly, you can use this function e.g. as a daily or weekly charge counter. Deleting the charges has no effect on the call data in the call data memory.

**Exchange line authorization:** You can configure with the configuration program *COMset* exchange line authorization (separate for business and private calls) for each subscriber. These authorizations are defining which type of numbers are allowed to be called by the subscriber (all national and international numbers, national numbers only or local calls only). A subscriber can also be limited to internal calls or accepting external calls only. Blocking numbers are limiting an exchange line authorization, Release numbers and Short-Code Dialling authorization are extending a limited exchange line authorization. These numbers can be modified with *COMtools* (p. 60).









### Configure Call Allowance

   
    
  secret password   
    
  internal subscriber number   
    
  number of units   
 

Set account to a certain number (0...9998) of units

or  unlimited

Set account to „without limit“

   
    
  secret password   
    
  internal subscriber number   
    
  number of units   
 







Raise the account by a certain number (0...9998) of units

 The Call Allowance can also be managed with the PC program COMtools (p. 60).

exchange line. With „Advice of charge at the end of the call (AOCE)“ the PBX can only find out at the end of the call, if the Call Allowance has been exceeded.

To use the function „Call Allowance“ without restrictions, you will need the feature „Advice of charge during the call (AOCD)“ for your ISDN







**Enquire Status of the Call Allowance**

 your telephone      7      public password      7      1      #     

Output of the account digit by digit followed by acknowledge tone (Example B: p. 8)

**Enquire Call Charge Sum**







**Enquire Call Allowance Accounts**

 your telephone      7      secret password      7      2      internal subscriber number      #     

Output of the Call Allowance account digit by digit, followed by an acknowledgement tone (Example B: p. 8)

**Enquire call allowance accounts of single subscribers**









**Enquire Call Charge Sum**

 your telephone      7      public password      7      1      #     

Output of the account digit by digit followed by acknowledge tone (Example B: p. 8)

**Enquire Call Charge Sum**

**Enquire Charge Sum**

 your telephone      7      secret password      7      1      internal subscriber number      #     

Output of the charge sum digit by digit, followed by an acknowledgement tone (Example B: p. 8)

**Enquire charge sum of single subscribers**

**Delete Charge Sum**

 your telephone      7      secret password      7      0      internal subscriber number      #

**Delete charge sum of single subscriber**

**You like to retrieve and analyse Call Charge Data**

The PBX has a permanent call charge data memory for 3000 data sets. A call charge data set contains the following information:

- Number of the call partner if presented.
- Exchange line and MSN used for the call.
- Date and time at call beginning.
- Call duration or ringing duration for unsuccessful calls.
- Charge units and call cost sum.
- Internal subscriber involved in the call.

- Internal group involved in the call.
- Type of call: Inbound or outbound, business or private, successful or unsuccessful.
- Project number if assigned to the call. (The number of digits for project numbers must be configured. The actual numbers can be random and assigned during the call.)

The bundled software for call charge data management COMlist and a PC connected to the PBX lets you manage, analyse and transfer call charge data from the PBX (p. 61).



If you do not like to analyse your data on the PC, but like to send the data directly to a printer, you can connect directly a serial printer to the serial port. You have to configure the parameters of the serial port in the printer (no handshake, 9600 baud, 8 bit data, 1 stop bit, no parity). The following shortcuts/IDs are used in the printouts:

- \* no number presented
- Ax:yyy Call via exchange line x and MSN yyy
- TNxxx Call of subscriber xxx
- I Type of call: Inbound.
- O Type of call: Outbound.
- B Type of call: Business.
- P Type of call: Private.
- U Type of call: Unsuccessful.
- Gxxx Call of group xxx
- Pxxxxxx Project number xxxxxx
- xxxmys Duration xxx minutes and yy seconds
- xxxxxe xxxxx units
- CF x Call Forwarding via exchange line x
- UPD Software update
- SOPR configuration via ext. S<sub>0</sub> port
- Alarm alarm call
- Door x Door to external call from door terminal x

**Continuous Call Data Output with Start/Stop Mode:** If the printer is always on and you like to see the call data of the call just finished you have to configure the serial port to operation mode „continuous call data output (chapter [Select Operation Mode of the Serial Interface on page 34](#)). If you like to remove the printer in this operation mode from time to time without losing data, you will need the start/stop command.

**Start-/Stop Command for the continuous Call Data Output**

secret password

1: start, 0: stop

**Start or stop continuous call data output**

**Call Data Printing on Demand**

secret password

internal subscriber number (0: all)

or 1

or 2

**Call data printing on demand of all calls of a subscriber**

**Call data printing on demand of all business calls of a subscriber**

**Call data printing on demand of all private calls of a subscriber**

If you like to have separate printouts for business and private calls, you have to configure the PABX to store these. With the

configuration software COMset you can limit the call data types to be stored to save memory space.

**Delete entire Call Data Memory**

secret password

**Delete entire call data memory**

You should enter the start command as soon as the printer is connected. From this start point on, call data will be sent and printed unconditional. If it is necessary to disconnect the printer, e.g. to make configuration settings with the PC, enter the stop command first. Calls made after the stop command will be saved and send/printed after the next start command.

If you do not enter the stop command, you will have to take into consideration that any call data of calls made in the meantime will never be printed and are lost.

**Call Data Printing on Demand:** If you want to print the call data of a certain subscriber on demand, connect the serial printer with the PBX and enter the output command. All call data present at this moment in the memory will be sent to the serial port printer. You can activate separate printouts for internal subscribers, business calls and private calls. In this case the operation mode „no special function“ has to be configured for the serial interface.

**Delete Call Data Memory:** If the memory is full, you can enable recording additional call data. In this case you have to configure „overwrite the oldest entries“ (Configuration with the configuration program COMset) or regularly delete the memory by telephone.

To print all information, a line width of 112 characters needs to be configured in the configuration program COMset. If a smaller line size is configured, certain columns will not be printed.

If you like to use call charge data with you own software, you have to configure the operation mode of the serial interface to „data exchange with external programs“.

PC and printer may not be connected to the serial interface at the same time.

## You like to use the Serial Interface for Special Functions

The default factory setting is „no special function“. Other operation modes are:

**Dial with a PC telephone:** An internal subscriber can use a PC dialler on a connected PC. This PC telephone needs to be configured in *COM-set*.

**Continuous call data output:** With this configuration, you can print your call data unconditional after the call to an attached printer. The start/stop command described later is needed for this operation mode.

**Data exchange with external programs:** With this configuration, you can transfer data to your own type of application program (this software is not included in the PBX package). Sending of the stored call data can be activated by sending a certain character to the PBX. With the character „\$“ you will activate the transfer of the first line. With the character „%“ you will activate the transfer of the next line. A character „%“ will only activate the transfer of a single line.

**D-channel protocol output in binary format:** With this configuration, the PBX will continuously send the D-channel protocol data of one or several channels in binary format (for service only).

**D-channel protocol output in ASCII format:** With this configuration, the PBX will continuously send the D-channel protocol data of one or several channels in ASCII format (for service only). You can analyse the protocol data with a terminal program.

**TAPI mode:** With this configuration, you can use the TAPI functionality (TAPI=Telephony Application Programming Interface) of the PBX. You can use your PBX with various Windows applications that support the TAPI interface (e.g. a dialler). Applications in Windows 95, 98, Me and Windows 2000 are supported. The TAPI driver is automatically configuring this operation mode, when an application is launched.

 *PC and printer may not be connected to the serial interface at the same time.*

### Select Operation Mode of the Serial Interface

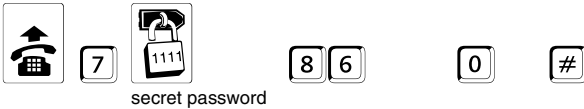

**Activate operation mode „No special function“**

or **1**

**Activate operation mode „Selection via PC with ATD command“**

or **2**

**Activate operation mode „Continuous call data output“**

or **3**

**Activate operation mode „Data exchange with external programs“**

or **4**

**Activate operation mode „D-channel protocol output in ASCII format“**

or **5**

**Activate operation mode „D-channel protocol output in binary format“**

or **6**

**Activate operation mode „TAPI mode“**

## You like to simplify the Dialling of external Numbers

To prevent entering frequently used external numbers each time, you can assign these numbers to a 4-digit Short-Code Dial Number. This Short-Code Dial Number will be dialled instead of the Exchange Line Access Number **0** + external number. The PBX will dial automatically the Exchange Line Access Number and the stored number.

The number can be stored with the bundled PC software *COMtools* (see also p. 60) into the Short-Code Dial Number memory. If no PC is available, the PBX offers the option to execute the following functions on your own telephone.

**Private Short-Code Dial Numbers:** These numbers are only available to the telephone used for programming. So you have to program the private Short-Code Dial Number with the telephone that will later be used to access the numbers.

**Emergency Short-Code Dial Numbers:** Enter Numbers as emergency Short-Code Dial Number that should be available for dialling to each subscriber with exchange line authorization. The permission to dial these numbers is part of each exchange line authorization.

Mandatory entries for the numbers are e.g. the emergency numbers of the fire brigade and the police. The emergency numbers 110 and 112 are stored in the default factory setting under 8110 and 8112.

To save time in a case of emergency, you can assign the entries in the emergency Short-Code Dial memory to 2 or 3 digit numbers (10-59;

100-599), e.g. with the number 110 (via configuration software *COM-set*).

The numbers 110 and 112 are assigned to 8110 and 8112 in the default factory settings. That means, if you dial 110 on your telephone, the PBX automatically dials the Short-Code number 8110 (Exchange Line Access Number **0** + external number **110**). The advantage is that even persons without PBX experience or knowledge of Exchange Line Access Numbers can dial these numbers without any problems.









You can store a maximum of 10 emergency numbers. You can choose from a numbering range of 8110 to 8199. If you try to program more than 10 digits with your telephone, you will hear the busy tone.

 *The telephone book of a connected system telephone (COMfortel 1500/2500 and COMfort 1000/1200/2000 plus) will be combined with the telephone numbers (with name) entered in the short-code dial memory of the PBX. To use these functions, the short-code dial numbers with names should be entered with the program *COMtools Telephone Book*.*









*With the program *COMtools Telephone Book* you can transfer some of the short-code dial numbers of the PBX into the telephone book of a connected system telephone COMfortel DECT 900 and COMfort DECT 800.*

You can enter „100-digit long Short-Code Dial Numbers“ with the PC software COMtools. These can contain letters and tokens to enter pre-defined messages to pagers.









### Enter public Short-Code Dial Numbers

							<b>Enter public Short-Code Dial Numbers</b>
		public password		Short-Code Dial Number	20-digit max. number (without Exchange Line Access Number „0“!)		
or							<b>Delete public Short-Code Dial Number</b>

### Enter private Short-Code Dial Numbers

							<b>Enter telephone number in the private Short-Code Dial Number memory</b>
your telephone		public password		Short-Code Dial Number	20-digit max. number (without Exchange Line Access Number „0“!)		
or							<b>Delete telephone number out of private short-dial number memory</b>

### Enter Emergency Short-Code Dial Numbers

							<b>Enter the Number into the Short-Code Dial Memory</b>
		secret password		Short-Code Dial Number	20-digit maximum number (without Exchange Line Access Number „0“!)		
or							<b>Delete Number from Short-Code Dial Memory</b>

 The emergency call priority function (configured in COMset) provides an exchange line in any circumstance for an emergency Short-Code Dial Number call to an external number. If all

exchange lines are busy, an active call will be terminated in favour of the emergency call. Please do not enter general Short-Code Dial Numbers here.

## You like to use the Wake-up Function of the PBX

To be reminded of single or recurrent dates by your own telephone, you can use the wake-up function.

Your telephone will ring at the configured time for 1 minute. If you accept this call, you will hear the Music on Hold.

**Single/Repetitive Wake-up:** The Wake-up time can be activated for a one-time or repetitive function. If you like to get a Wake-up call always at the same time, you have to configure „repetitive Wake-up“. The Wake-up function will be active until you switch it off. Once configured, the Wake-up time will be stored until you configure a different one.













Example: You have activated the Wake-up time „Monday to Friday at 12.30 clock“. If you did this activation on a Sunday evening for „Wake-up once“, you will be waked up on the following Monday at 12.30 clock. The Wake-up function will be deactivated then. If you have configured the same Wake-up time repetitive, you will be waked-up also from Tuesday until Friday at 12.30 clock (every week, until Wake-up is deactivated).

 The Wake-up times can also be configured with the PC software COMtools (p. 60).













On each telephone **one** Wake-up time can be configured.

After a power failure the time information is lost. In this case automatic switching and the Wake-up function will not be performed. After adjusting the time by the programming sequence on p. 47 or by an outbound external call the functions will be active again (you can configure in COMset an automatic call to a number e.g. your own number for this purpose).









**Configure Wake-up Time and activate the Function for one single Wake-up**

			 		  		<i>e.g. for 1:</i> <b>Set Wake-up time for Mo and activate for one single Wake-up on the first possible Wake-up time</b>
your telephone		public password		time: 00-23 (hours), 00-59 (minutes)	Day 1-7: Monday - Sunday		
<b>or</b>							
							<b>Set Wake-up time for Sat and Sun and activate for one single Wake-up on the first possible Wake-up time</b>
<b>or</b>							
							<b>Set Wake-up time for Mon, Tue, ..., Fri and activate for one single Wake-up on the first possible Wake-up time</b>
<b>or</b>							
							<b>Set Wake-up time for Mon, Tue, ..., Sun and activate for one single Wake-up on the first possible Wake-up time</b>

**Configure Wake-up Time and activate the Function for repetitive Wake-up**

			 		  		<i>e. g. for 1:</i> <b>Set Wake-up time for each Mon and activate for repetitive Wake-up</b>
your telephone		public password		time: 00-23 (hours), 00-59 (minutes)	Day 1-7: Monday - Sunday		
<b>or</b>							
							<b>Set Wake-up time for each Sat and Sun and activate for repetitive Wake-up</b>
<b>or</b>							
							<b>Set Wake-up time for each Mon, Tue, ..., Fri and activate for repetitive Wake-up</b>
<b>or</b>							
							<b>Set Wake-up time for each day and activate for repetitive Wake-up</b>

**Switch on Wake-up**

			 		<b>Activate for one single Wake-up without time because time has already been saved</b>
your telephone		public password			
<b>or</b>					
			<b>Activate repetitive Wake-up without time because time has already been saved</b>		

**Deactivate Wake-up Function**

			 		<b>Deactivate Wake-up Function</b>
your telephone		public password			

### Enquire Wake-up Time



your telephone

public password

Output of the account digit by digit followed by acknowledgement tone (5th digit is the day of the week 1-7: Monday- Sunday 8: Saturday and Sunday, 9: Monday until Friday, 0: Every day) (Example: p. 8)

*Enquire Wake-up Time*

### You like to configure internal Dial Tones and listen to the Result

Various tones in the receiver are representing different status information about the PBX. The PBX is generating the following tones:

- **External dial tone:** This tone is a continuous dial tone. You will hear this tone after dialling the Exchange Line Access Number (Direct Exchange Line Telephone: After taking the receiver off-hook) as a signal for access to the exchange line.
- **Internal dial tone:** After taking the receiver off-hook or pressing the FLASH- or R-Key you will hear this tone. This signals that you can start to dial a number now. In the default factory settings, the PBX dial tone (3 x short) is configured as an internal dial tone. If you prefer to have another tone, you can configure the continuous or special dial tone ([chapter Change internal Dial Tone on page 37](#)).
- **Acknowledgement tone:** You will hear this tone in the programming mode, e.g. as a signal for entering the correct password or the completion of a programming.
- **Busy tone:** This tone signals a busy line, a mistake in a programming sequence or a missing permission (see also [chapter You are Dialling a Number and are Hearing the busy Tone on page 13](#)).

- **Special dial tone:** This tone instead of the internal dial tone signals an active Do-Not-Disturb, baby call or subscriber Call Forwarding service. It signals also an almost filled call data memory. If you configured this tone as an internal dial tone, this signalling will not be possible any more.
- **Ringing Tone:** This tone will be generated after dialling a number or when accepting a recall as a signal for calling a subscriber.
- **Call Waiting Tone:** This tone is signalling another external caller trying to reach you. It is also generated by an inbound door or alarm call.

**Internal dial tone:** In the default factory settings, the PBX dial tone (3 x short) is configured as an internal dial tone. If you prefer to have another tone, you can change this setting.

**Listen to internal dial tones:** If you hear a different tone than described here in the manual, this is most of the time a sign for a failed sequence or missing authorization. To get familiar to the tones, you can listen to the tones with your phone.

#### Representation of the tones:

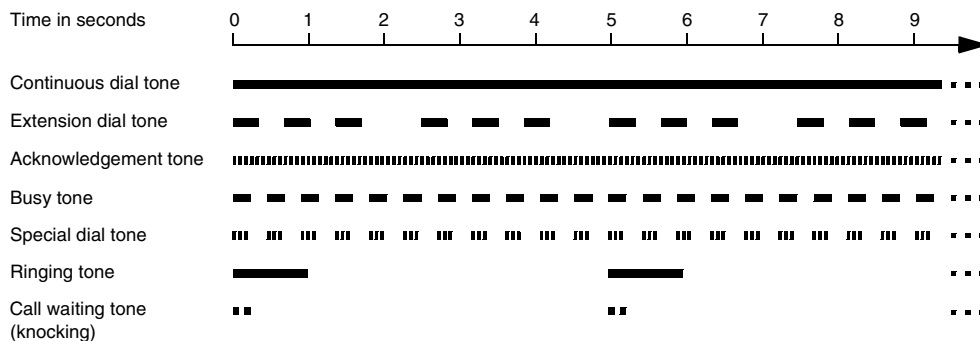

### Change internal Dial Tone



your telephone

public password

*Change to continuous dial tone*

or 1

*Change to PBX dial tone (3 x short)*







or 2

*Change to special dial tone (intermittent pulse)*

These settings are configuration dependent.



### Configure Ringer Rhythm for internal Calls

















**Change to ringer rhythm 1 x long**

your telephone      public password      1 x long

or  **Change to ringer rhythm 3 x short**

3 x short

### Change Ringer Rhythm for external Calls









**Set ringer rhythm „1 x long“**









secret password      Number or. MSN/DDI of your exchange line  
(without area code)

or  **Set ringer rhythm „3 x short“**

or   
...  
7 **Set special rhythms No. 1-6**

 The default is 1 x long for each existing telephone number.

### Listen to Ringer Rhythms for internal, external and Alarm Calls









**Listen to ringer rhythm 1 x long**

analog telephone      public password      1 x long      Telephone is ringing in the selected rhythm  
(60 seconds or until receiver is taken off-hook)

or  **Listen to ringer rhythm 3 x short**

3 x short

or   
...  
7 **Listen to special rhythm 1...6**

special rhythms No. 1-6  
(for external calls only)

or  **Listen to alarm call**









alarm call

 As ISDN telephones most often support their own ringer melodies only and not the melodies of the PBX, you may listen with analog telephones only.

### Make a Call without any Dialling Operation (Automatic Dialling / Hot Line)

With the automatic dialling function you can configure your telephone to dial automatically an internal or external number. This will start 2 seconds after taking the receiver off-hook. It is not necessary to press any key. If you start to dial before these 2 seconds have elapsed, this has priority. Please pay attention to the fact that some telephones do not dial immediately after pressing the key (sometimes delayed by  $\frac{1}{2}$  second). In this case, you have to start dialling in time!

### Configure Automatic Dialling / Hot Line

						<b>Switch on Automatic Dialling with entry of an internal subscriber telephone number as destination</b>
your telephone		public password		internal number of the target telephone		
				or 		<b>Switch on Automatic Dialling with entry of an external number as destination</b>
				or 		<b>Switch on Automatic Dialling with entry of a Short-Code Dial Number as destination</b>
				Exchange Line Access Number and external number of the target telephone		
				Short-Code Dial Number		

### Switch on/off Automatic Dialling / Hot Line

					<b>Switching on Automatic Dialling without Entry of a Number, because Number is already configured</b>
your telephone		public password			
					<b>Switching off Automatic Dialling (Start Dialling within 2 Seconds)</b>
your telephone		public password			

 You can also use the T-Net sequence, you can activate the „connection without dialling“ with \*53\* + number + # and deactivate with #53#. If you are using an analog telephone that de/activates „connection without dialling“ by T-Net function key/menu, you can use this comfortable functionality (see manual of the telephone; eventually named „direct call“). Instead of the announcement of the public exchange, you will get an acknowledgement tone.

If you are asked to enter a target number when using the T-Net functions, you have to enter the Exchange Line Access Number 0 for external numbers. On the PBX you are also able to enter Short-Code Dial Numbers and internal numbers.







 These settings are configuration dependent.

### You want to listen into a Room (Room Monitoring)

If you like to listen into a room, e.g to check if your baby sleeps, you can use the function „Room Monitoring“ of the PBX. The internal telephone has to be configured for this function. The room monitoring can be done with an internal as well as an external telephone.

After the configuration the receiver will be placed near the telephone. A secret monitoring is not possible.

### Enable the Room Monitoring on an internal Telephone

						<b>Start Room Monitoring to be able to listen into the room</b>
telephone in the room to be monitored		public password			<b>Place the receiver near the telephone.</b>	

 It is not possible to make a call from this telephone.  
 It is only possible to enable a single telephone for Room Monitoring at the same time.  
 To deactivate Room Monitoring, replace the receiver of the telephone.



### Listen into the Room from an internal Telephone



**Perform the Room Monitoring from an internal telephone**

### Listen into the Room from an external Telephone

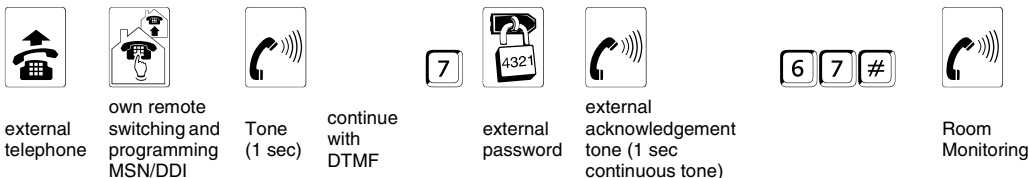

**Perform the Room Monitoring from an external telephone**

You are in need of an analog DTMF telephone, an ISDN telephone with DTMF signalling or a DTMF sender.

The PBX needs to be configured with the configuration program COMset for this purpose.

You need to know the remote switching and programming MSN/DDI configured with the configuration program COMset.

If you wait too long with entering the code sequence or enter the wrong code, you will hear the busy tone. Replace the receiver and try again.

### Door Terminal Calls should always reach you

If a visitor rings on the door when you are away from home, you are able to connect the door terminal e.g. to your mobile telephone. If the external Call Forwarding is activated for a door key, an external subscriber (e.g. your mobile phone) will be called if the key is pressed. As soon as the called party is taking the call, the communication between the door terminal and the called party is established.

The first programming step is assigning the door key to an external number. The external number needs to be stored as a Short-Code Dial Number for this function.

The second programming step is switching the external Call Forwarding from the door terminal on or off. The Short-Code Dial Number setting will not be changed by switching on and off.

If you configured with the configuration program COMset the door terminal call for an answering machine subscriber, this answering machine can also connect to the door terminal call in your absence).

### Connect the Door Terminal to an external Subscriber (External Call Forwarding from the Door Terminal)

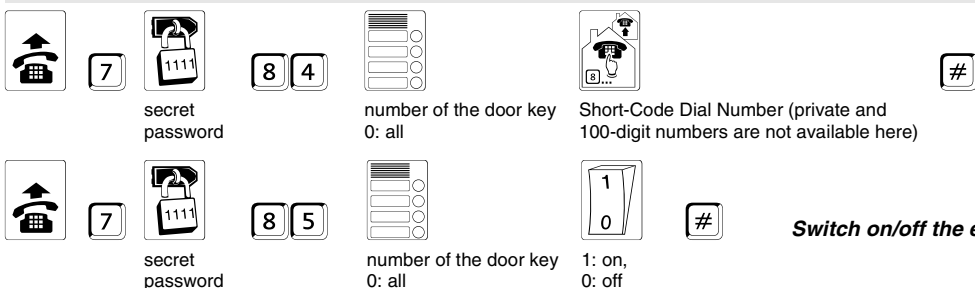

**Enter destination number of the external Call Forwarding from door terminal**

This function is only possible by using a door/switching module (not enclosed).

The door keys on the module slot B have the numbers 1 and 2. The door keys on the module slot C (only COMPACT 4410 USB) have the numbers 3 and 4.

The destination number is configuration dependent.

### Use the Remote Switching Relay (via Telephone)

If your PBX was equipped with a door or switch module and if you use one of the existing relays as an universal switching relay, you can switch these in different ways, also with an internal or external telephone.

For the corresponding relay the „Universal Mode“ has to be activated in the configuration program COMset. A door relay e.g. cannot be switched/connected in this way.

Depending on the configuration of the universal switching relay, it can be switched in different ways. So it can be e.g. switched in addition to the remote switching also configuration dependent. (e.g. it is switched

on „every night“ or „during lunchtime“). The relay is only really switched off if it was switched off in the same way it was switched on. So if you switched on a relay via the here described function, you will have to switch it off the same way, too.

### Remote Switching via internal Telephone

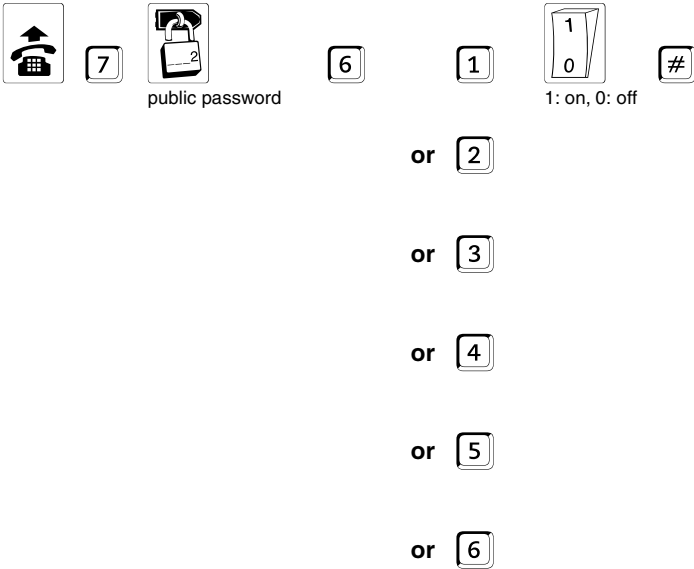

Switch on or off the 1st relay  
(COMPact 2206/4410 USB: „TS“ on module slot B,  
COMmander Basic: „TS11/TS12“)

Switch on or off the 2nd relay  
(COMPact 2206/4410 USB: „TO“ on module slot B,  
COMmander Basic: „TO11/TO12“)

Switch on or off the 3rd relay  
(COMPact 2206/4410 USB: „REL“ on module slot B,  
COMmander Basic: „REL3 com/no/nc“)

Switch on or off the 4th relay  
(COMPact 4410 USB: „TS“ on module slot C,  
COMmander Basic: „TS21/TS22“)

Switch on or off the 5th relay  
(COMPact 4410 USB: „TO“ on module slot C,  
COMmander Basic: „TO21/TO22“)

Switch on or off the 6th relay  
(COMPact 4410 USB: „REL“ on module slot C,  
COMmander Basic: „REL6 com/no“)

On the system telephone COMfortel 1500/2500, COMfort 1000/1200/2000 plus and smar-tel-i (only on COMmander Basic) the relays can be switched comfortably via menu (see manual of the telephone).

If you like to switch a remote switching relay from an internal telephone, this telephone needs the remote switching authorization (in the default factory setting all subscribers have the remote switching authorization).

### Remote Switching via external Telephone



Start remote Programming

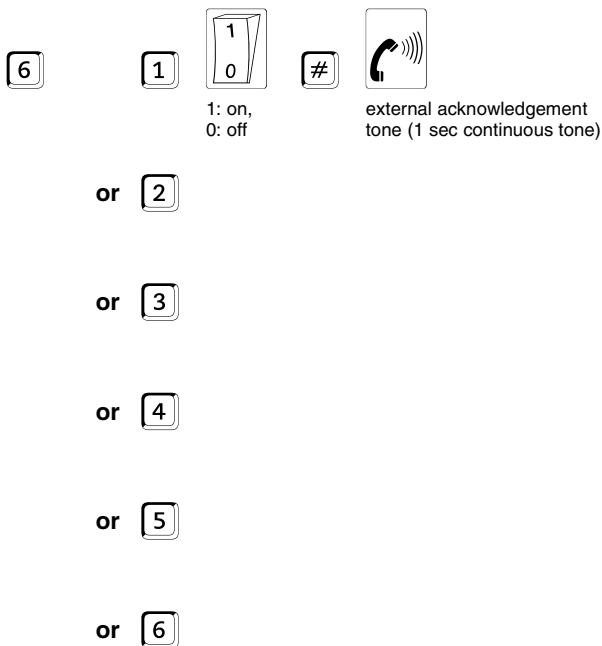

Switch on or off the 1st relay  
(COMPact 2206/4410 USB: „TS“ on module slot B,  
COMmander Basic: „TS11/TS12“)

Switch on or off the 2nd relay  
(COMPact 2206/4410 USB: „TO“ on module slot B,  
COMmander Basic: „TO11/TO12“)

Switch on or off the 3rd relay  
(COMPact 2206/4410 USB: „REL“ on module slot B,  
COMmander Basic: „REL3 com/no/nc“)

Switch on or off the 4th relay  
(COMPact 4410 USB: „TS“ on module slot C,  
COMmander Basic: „TS21/TS22“)

Switch on or off the 5th relay  
(COMPact 4410 USB: „TO“ on module slot C,  
COMmander Basic: „TO21/TO22“)

Switch on or off the 6th relay  
(COMPact 4410 USB: „REL“ on module slot C,  
COMmander Basic: „REL6 com/no“)

You are in need of an analog DTMF telephone, an ISDN telephone with DTMF signalling or a DTMF sender.

The PBX needs to be configured with the configuration program COM-set for this purpose.

You need to know the remote switching and programming MSN/DDI configured with the configuration program COMset.

If you call the PBX and enter the correct external password as described here, you will hear the external acknowledgement tone. Now you use the same programming digits as from the internal telephone (after the password). Then you will hear the external acknowledgement tone again.

If you wait too long with entering the code sequence or enter the wrong code, you will hear the busy tone. Hang up the receiver and try again.

If you entered by mistake a relay not configured for remote switching, you will hear an alternating high and low tone (negative acknowledgement tone). You will be able to start again from this situation - after this tone - unconditional.

## You like to use the Security Functions

**Alarm functions:** If your PBX is equipped with a door/switching module and an alarm input on the module is properly connected, you can also use the alarm functions. Alarm functions are the activation of a siren and alarm indicator light (via switching relay) and the repetitive alarm calls to a maximum of 4 alarm subscribers (internal and external). The alarm subscribers will listen to an alarm announcement (**COMPact 4410 USB** and **COMmander Basic only**). This can be recorded by telephone (p. 47) or stored with the program **COMtools Music on Hold** (p. 60) in the PBX.

### The Alarm Procedure:

- Alarm detection at the alarm input (contact closed longer than ½ a second).
- The configurable alarm delay time is running (0-99 seconds).
- Non recurring start of the siren (for 1-99 seconds) and/or the alarm indication light (for 1-99 minutes).
- Simultaneously the first alarm call run starts (Alarm calls to the alarm subscribers):
  - Calling the first alarm subscriber for 60 seconds. Internal alarm subscribers are called with a special ringer rhythm (ISDN telephones: See manual of your telephone).
  - After taking the receiver, you will hear an alarm announcement stored in the PBX (**COMPact 4410 USB** and **COMmander Basic only**; p. 47) again and again (in case of **COMPact 2206 USB** you hear a signal tone instead). The called party must acknowledge the alarm call within 60 seconds by sending the DTMF number  (p. 22).
  - If the called party does not acknowledge the alarm call, the next alarm subscriber will be called some seconds after finishing the first call. And so on.....

- If all alarm subscribers are called without receiving an acknowledgement, the alarm run will be repeated after a configurable alarm waiting period (0-99 seconds) has elapsed (you can configure 1-10 alarm runs).
- The alarm will be terminated (including siren and alarm indication light) as soon as one of the alarm subscriber acknowledges the alarm. If the alarm input has been configured to „active once“, it is deactivated afterwards. If the alarm input has been configured to „active repetitive“, it is activated again and a new alarm can be triggered.

**Activate Alarm:** You can activate the alarm with an internal or an external telephone. If the alarm input has been configured to „active once“, it is deactivated automatically afterwards. If the alarm input should remain active after being triggered, configure it to „active repetitive“. (The alarm input is deactivated in the default factory settings.)

 One of the security functions of the PBX is the emergency call priority function activated by the configuration program COMset. This function provides an exchange line at any circumstance for an emergency call or an alarm call to an external number. If all exchange lines are busy, an active call will be terminated in favour of the emergency call. The numbers can be entered with the PC software COMtools (p. 60) or by telephone (p. 35).

If you like to reach one single number from a telephone in a very simple way, you can use the Automatic Dialling (p. 39).

If you like to listen into a room from internal or external telephones, you can use the room monitoring (p. 40).

### Activate Alarm via internal Telephone



**Activate the alarm function for one single alarm**

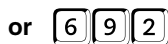

**Activate the alarm function for multiple alarms**

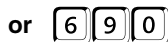

**Deactivate the alarm input**

### Activate Alarm via external Telephone



**Start external Programming**

6 9 1

#



external acknowledgement tone  
(1 sec continuous tone)

**Activate alarm input for one single alarm**

or 6 9 2

**Activate alarm input for multiple alarms**

or 6 9 0

**Deactivate alarm input**

You are in need of an analog DTMF telephone, an ISDN telephone with DTMF signalling or a DTMF sender.

The PBX has to be configured properly with the configuration program COMset.

You must have knowledge of the remote switching and programming MSN/DDI and the external password configured with the configuration program COMset.

If you call the PBX as described here and enter the correct external password, you will hear the external acknowledgement tone. You can now use the same programming sequence as from internal (after the password). At the end you will hear the external acknowledgement tone again.

If you wait too long with entering the code or enter the wrong code, you will hear the busy tone. Hang up the receiver and try again.

## You like to change the Music on Hold/Announcement

**Music on Hold:** If you make a transfer or Query, the calling partner in the background will hear a Music on Hold combined with an optional announcement.

The Music on Hold is stored in the PBX (internal Music on Hold) or is provided as external Music on Hold via an audio input (on the COMmander Basic only possible after the extension with a door/switching module).

The PBX systems COMpact 4410 USB and COMpact 2206 USB already have a selection of 7 internal Music on Hold melodies. The PBX systems COMpact 4410 USB and COMmander Basic allow the storage of an individual internal Music on Hold.

**Music on Hold announcement:** The PBX systems COMpact 4410 USB and COMpact 2206 USB have a pre-recorded Music on Hold announcement. The PBX system COMmander Basic offers the option to record an individual Music on Hold announcement. There is no limitation for mixing the existing Music of Hold with the announcement and the length of the pause between the announcements can be configured.

**Alarm announcement:** If your PBX is equipped with a door/switch module and the alarm input on the module (unused door key input) is properly connected (e.g. to the output of an alarm system), you can record an alarm announcement for the call to the alarm subscribers.

The described functions can also be configured via PC.

## Recording internal Music on Hold with the PBX (COMpact 4410 USB and COMmander Basic only)



7



secret password

4 3

#



You will hear some short tones and then the acknowledgement tone

\*



Press the star key to start the recording and switch on the music output device simultaneously.

#

stop recording

**Fade in music on hold and save**

This function will delete the existing Music on Hold directly (does not apply to the 7 pre-recorded internal Music on Hold melodies of the COMpact 4410 USB). Even if you hang-up after dialling 4 3 # the old Music on Hold will already be deleted. The Music on Hold may have a maximum length of 120 seconds (COMpact 4410 USB: 128 seconds). After this time the recording will automatically be stopped and you will hear the acknowledgement tone. If you are using a shorter Music on Hold, you can stop the recording unconditional by hang-up or pressing the # key.

The music must be provided on the audio input (on COMmander Basic only after extension with a door/switching module).

COMpact 4410 USB: If you have also stored a recorded Music on Hold in the PBX, its playing time will be shortened by recording an announcement (alarm and/or „Announcement before Answering“). You will not have the 128 seconds for the Music on Hold at your disposal. In case of „Announcement before Answering“ 48 seconds of music time (24 seconds of talking) will be lost, in case of an alarm announcement 32 seconds of music time (16 seconds of talking). So 48 seconds will be available for the Music on Hold.

For the PBX COMpact 2206 USB the recording of individual Music on Hold melodies is not possible.

To play external music or Music on Hold recorded by yourself, please note that some music songs are subject to a fee to the copyright holder. Please ask the corresponding authorities.

**Recording the Music on Hold Announcement via Telephone (COMmander Basic only)**

secret password  
 You will hear the acknowledgement tone  
 start recording  
 speak the announcement  
 stop recording

**Record Music on Hold announcement and store it**

This function will delete the existing Music on Hold announcement directly. Even if you hang-up after dialling the old Music on Hold announcement will already be deleted. The Music on Hold announcement may have a maximum length of 8 seconds. After 8 seconds the recording will be stopped automatically and you will hear the acknowledgement tone. If you are using a shorter Music on Hold

announcement, you can stop the recording unconditional by hang-up or pressing the key.  
 The Music on Hold announcement is directly recorded from the receiver of an internal telephone.  
 You have the alternative option to store the announcement as .wav file with the PC software COMtools.

**Configure and mix Music on Hold and Announcement**

secret password  
**Switch off Music on Hold and announcement**

or **Switch on announcement (without Music on Hold)**

or **Switch on internal Music on Hold (without announcement)**

or **Switch on internal Music on Hold mixed with announcement**

or **Switch on external Music on Hold (without announcement)**

or **Switch on external Music on Hold mixed with announcement**

COMpact 4410 USB or COMpact 2206 USB: In case of configuring „internal Music on Hold (with or without announcement)“ the internal Music on Hold needs to be selected ([chapter Select and lis-](#)

[ten to internal Music on Hold \(COMpact 4410 USB and COMpact 2206 USB only\) on page 46](#)).

**Configure the Delay Time between Announcements**

secret password  
**Configure pause length from 0 to 30 seconds between the Music on Hold announcements**

pause length 0-30 seconds

**Select and listen to internal Music on Hold (COMPact 4410 USB and COMPact 2206 USB only)**

7

4
9
0
#

#

secret password      you hear the music      stop

*Select self-recorded music or pre-recorded .wav file as internal Music on Hold and listen to it (COMPact 4410 USB only)*

- or 1 *Select and listen to „American Patrol“ as internal Music on Hold*
- or 2 *Select and listen to „Carmen“ as internal Music on Hold*
- or 3 *Select and listen to „For Elise“ as internal Music on Hold*
- or 4 *Select and listen to „The Entertainer“ as internal Music on Hold*
- or 5 *Select and listen to „Minuet: L. Boccherini“ as internal Music on Hold*
- or 6 *Select and listen to „Minuet: G. Ph. Telemann“ as internal Music on Hold*
- or 7 *Select and listen to „Minuet: Pucchini“ as internal Music on Hold*

 *The internal Music on Hold saved in the PBX (including the enclosed .wav files) may be used without fees to copyright agencies.*

**Listen to Music on Hold and Announcements**

7

4
6
1
#

#

secret password      you will hear the music/announcement      stop

*Listen to announcement (without Music on Hold)*

- or 2 *Listen to internal Music on Hold (without announcement)*
- or 3 *Listen to internal Music on Hold mixed with announcement*
- or 4 *Listen to external Music on Hold (without announcement)*
- or 5 *Listen to external Music on Hold mixed with announcement*

 *COMPact 4410 USB or COMPact 2206 USB: If you like to listen to a certain "internal music on hold (with or without announcement)", it has to be selected first (p. 46).*

### Record the Alarm Announcement by Telephone and listen to it (COMpact 4410 USB and COMmander Basic only)

secret password      you hear the acknowledgement tone      start recording      Record the announcement.      stop recording      **Record alarm announcement and store it**

---

secret password      you hear the announcement      stop      **Listen to the stored alarm announcement**

With the recording function any existing announcement will be deleted unconditional. Even if you hang-up after dialling 442#, the old announcement will already be deleted. The announcement may have a maximum length of 16 seconds (COMmander Basic: 15 seconds). After this period the recording will be stopped automatically and you will hear the acknowledgement tone. If you are using a shorter announcement, you can stop the recording unconditional by hang-up or pressing the # key.

The announcement is directly recorded from the receiver of an internal telephone. You have the alternative option to store the alarm announcement as .wav file with the PC software COMtools.

The alarm announcement may have the following content:  
 Name and address of the PBX location;  
 Reason of the alarm trigger;  
 Information about alarm acknowledgement (Dialling of the digit 0 within 60 seconds with a DTMF telephone or a DTMF sender).

COMpact 4410 USB: If you have also stored a recorded Music on Hold in the PBX, its playing time will be shortened by recording an announcement. (see chapter Recording internal Music on Hold with the PBX (COMpact 4410 USB and COMmander Basic only) on page 44).

For the PBX COMpact 2206 USB no alarm announcement is possible. In case of an alarm call you will hear a signal tone instead.

### You like to set Date and Time

For the functions Wake-up and configuration switching your PBX needs the correct time. After a power failure the time information is lost. In this case automatic switching and the Wake-up function will not be performed. After adjusting the time by this programming sequence or by an

outbound external call (may be deactivated) the functions will be active again (you can configure in COMset an automatic call to a number e.g. your own number for this purpose).

secret password      4-digits time: 00-23 (hours) and 00-59 (minutes)      **Set time**

---

secret password      6-digits date: 01-31 (day), 01-12 (month), 00-99 (year)      **Set date**

### You like to park Calls with a Parking Code

You like to park an external call on a Point-to-Multipoint connection (external S<sub>0</sub> port) and retrieve that call with an ISDN device connected at the same bus (or vice versa), you will need a code number (see [chap-](#)

[ter Parking external Call on the external S<sub>0</sub> Port \(For Point-to-Multipoint Connection only\) on page 16](#)). With this programming you can park calls always with a park code from within the PBX.

#### Set Code Digits

secret password      2 code digits      **Enter Code Digits**

---

secret password      **Delete Code Digits**

The functions described in this paragraph are especially intended for the business applications. Nevertheless they could also be used in private homes to e.g. save money with Call Through.

## Reception and Secretary Function and Text before Answering

**Waiting Loop:** This function offers an indirect transfer of an external calling partner to an internal subscriber if this one is busy. The external calling partner can be put into the waiting loop. There he is held for up to 3 minutes and is listening to the Music on Hold in the meantime. If the corresponding internal subscriber is not busy anymore, he will be called for up to 60 seconds. If he takes the call, he will immediately be connected to the external subscriber.

A special configuration of the function is not necessary.

**Waiting Field:** (only available for *COMpact 4410 USB* and *COMmander Basic* in combination with a system telephone *COMfort 2000 plus* or *COMfortel 1500/2500*) This function enables the configuration of a Waiting Field Reception that can park, retrieve or forward inbound exchange line calls in a Waiting Field (these are listening to the Text before Answering once and then to Music on Hold). The Waiting Field is especially useful if many calls have to be taken at the telephone reception at the same time. Depending on the number of available external B channels up to 8 calls can be taken and managed.

The selection of a subscriber as a Waiting Field Reception is done with the configuration program *COMset*.

Record a „**Announcement before Answering**“ via telephone or load it via .wav-file into the PBX with the program *COMtools* (p. 60). If you have not stored or recorded any announcement, the caller will only hear the Music on Hold.

The usage and configuration of the **Waiting Field Reception** is described in detail in the manual of the system telephone.

**Boss-/Secretary function:** (only in combination with a system telephones *COMfortel 1500/2500* and *COMfort 1000/1200/2000 plus*) This function shields the boss' telephone against direct calls by redirecting these calls to the secretary's telephone. The main difference to a standard call forwarding is, that the boss' telephone can be reached from the

secretaries telephone and important calls can be switched from the secretary to the boss' telephone.

The usage and configuration of the Boss/Secretary function is described in detail in the manual of the system telephone.

**Announcement before answering:** (only available for *COMpact 4410 USB* and *COMmander Basic*) This function enables a welcome message to the caller before taking the call. If a called subscriber does not take the receiver when it rings once (within 5-24 seconds), the call will be taken by the PBX (the external caller will be charged). The external caller will hear a welcome message (e.g. information on the company) while the called telephone is still ringing. As soon as one of the called subscribers picks the receiver up, he will be connected to the external caller.

Record a „**Announcement before Answering**“ via telephone or load it via .wav-file into the PBX with the program *COMtools* (p. 60). The function can be initiated by the configuration program *COMset* or you can configure a key on the system telephone to switch on/off the Announcement before Answering. This switching is separately done for each external telephone number.

**Automatic Reception:** (only *COMpact 4410 USB* and *COMmander Basic*) This function enables the automatic transfer of an external caller to his requested call partner/contact person. The caller hears an announcement (e.g. „If you like to talk to the sales department, please press 1 ...“) and can call a certain internal subscriber or group by dialling a DTMF digit between 0 and 9.

If the caller has not already dialled a DTMF digit after the end of the announcement, the announcement will be repeated once. After the second time without dialling a DTMF digit the subscriber configured for the DTMF digit 0 is automatically called (e.g. the reception).

The Text before Answering is used as announcement. This can be loaded with the program *COMtools Music on Hold* (p. 60) into the PBX or via telephone. The function can be switched on/off via configuration program *COMset* or via telephone – also configuration dependent.

## Internal Subscriber is busy – Put the external calling Partner into the Waiting Loop



busy tone



back to the external call  
(automatically)



(ignore with  
pulse dial)



acknowledgement  
tone





hang up

**Put the external calling partner into the Waiting Loop after trying to transfer him**

 If the internal subscriber does not pick up within the 60 seconds or if he stays busy during the whole 3 minutes, your telephone as the transferring party will be called again. If you pick up the receiver, you will be reconnected to external calling partner again and will be able to put him into the Waiting Loop again. But if you do not take this call within 60 seconds, the exchange line connection will be completely disconnected (if you were busy in the mean time, perhaps also within a shorter time period).

If you like to transfer an external 2nd calling partner to an internal 3rd calling partner during a Query call (see p. 18), you will be able to put him

also into the Waiting Loop with   on busy. With an ISDN telephone you may have to press a function key after the acknowledgement tone in order to return to the 1st calling partner (e.g. with „end“, „separate“, „back“ or pressing the R-key again; see manual of the telephone).

 For many ISDN telephones and on the system telephone *COMfortel 1500/2500*, *COMfort 1000/1200/2000 plus* and *smar-tel-i* (on *COMmander Basic* only) the „Finishing a Query on busy“ is not executed automatically but via function key or via menu (e.g. with „end“, „separating“, „back“ or pressing the R-key again; see manual of the telephone).

## Activate/deactivate the Automatic Reception



secret password



1: on, 0: off



**Activate/deactivate the Automatic Reception**



The settings configured in the configuration program *COMset* concerning the call distribution remain to be unchanged.

These settings are configuration dependent (see p. 23).

### Recording the Welcome Message (Announcement before Answering) with a Telephone

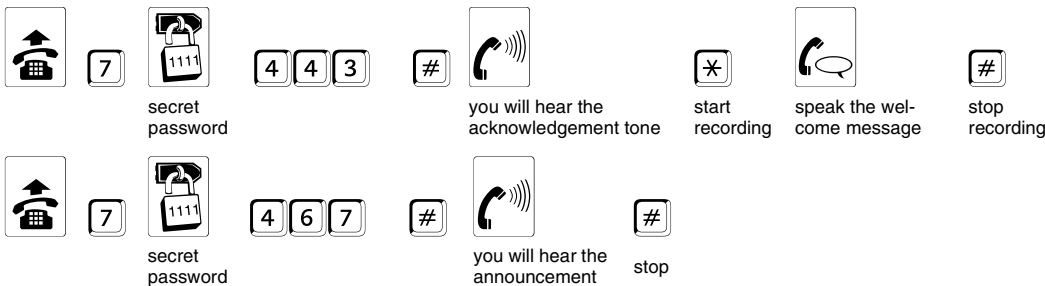

**Record and save Welcome Message „Announcement before Answering“**

**Listen to stored Welcome Message**

This function will delete the existing welcome message immediately. Even if you hang-up after dialling [4][4][3][2], the old welcome message will already be deleted. The welcome message may have a maximum length of 24 seconds. After 24 seconds, the recording will be stopped automatically and you will hear the acknowledgement tone. If you are using a shorter welcome message, you can stop the recording by hang-up or pressing the [M] key. The welcome message is recorded directly from the receiver of an internal telephone. The other

option is to transfer the Announcement before Answering as a .wav file with the PC software *COMtools*.

**COMPact 4410 USB:** If you have also stored a recorded Music on Hold in the PBX, its playing time will be shortened by recording an announcement. (see chapter *Recording internal Music on Hold with the PBX (COMPact 4410 USB and COMmander Basic only)* on page 44).

With the PBX *COMPact 2206 USB* no „Announcement before Answering“ is possible.

### Use Call Data to separate Call Charges

**Separation of private and business calls:** The private exchange line access enables a separated registration of business and private calls for individual employees. Calls started with the private exchange line access will get a special code in the call data memory. If private calls at work have to be paid by the employee himself, he can additionally protect his telephone with a password against malicious use.

The following settings/authorizations are separately managed for business and private calls: Call number presentation, activation of Blocking or Release numbers, short-code dial number authorization, preferred exchange lines, charging of the call allowance.

In the **call charge data recording** it is possible to **record** the telephone numbers of private calls **truncated** to guarantee privacy in opposite to business calls.

These settings are made in the configuration program *COMset*. The private password can also be changed on the corresponding telephone.

**Project assignment:** The project assignment enables the assignment of an external call to a certain project/client (e.g. within a lawyer's office). In the view of the call data management program the charges as well as the time expense can separately be listed for the different projects/clients.

The project numbers may be invented while starting the outbound call, only the number of digits have to be configured once (2 to 6 are possible).

In case of the system telephones *COMfortel 1500/2500* and *COMfort 1000/1200/2000* plus the length of the project numbers between 2 to 6 digits is also not limited during the entry. Besides this a project assignment is also possible in case of inbound calls.

### Start external Call with private Exchange Line Access



**Start external call**

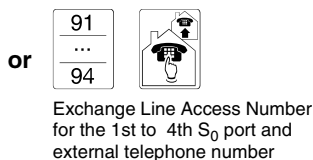

**Start external call via 1st to 4th exchange line (COMPact 4410 USB and COMmander Basic only)**

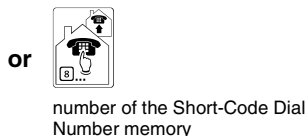

**Start private external call with Short-Code Dial Number**

In the default factory settings no private password is entered. Therefore a private call is started only with [9][0], the Exchange Line Access Number and the external telephone number.

The access code for the private exchange line access can also be used for connecting or starting a Query.

### Change private Password



The digit „0“ is not allowed in the password. If the password needs to be shorter than 4 digits, the remaining unused digits will have to be filled with „0“ during programming. Example: You like to use the password [6][7]. You have to enter as „new password“ [6][7][0][0]. When telephoning later, you only need to enter [6][7] as a password.

If you do not like your password to be compromised, you better avoid assigning the password to a target dial key. If you have a display in the telephone, you should perform the following procedure after programming: Take the receiver, dial a random digit and replace the receiver. This way, you avoid to store your password in the redial memory that anybody can retrieve in your absence.

### Start external Call with Project Assignment

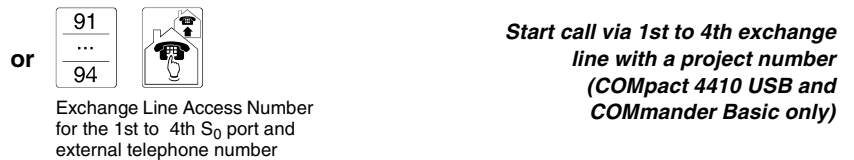
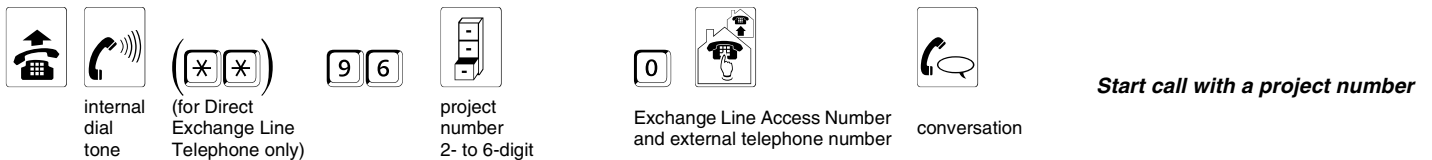

With the configuration software COMset can be configured how many digits a project number will have (2-6 digits; 2 in the default factory settings).

## Announcements via Loudspeaker and System Telephones

**Announcement/handsfree operation (InterCom) via system telephone:** (only in combination with the system telephones *COMfortel 1500/2500* and *COMfort 1000/1200/2000* plus as well as *smar-tel-i* on *COMmander Basic*) This function enables an announcement to a system telephone from any available internal telephone without actively taking the call at the target telephone (e.g. in a doctor's office).

Besides this you can instruct a system telephone to switch on the microphone in addition to the loudspeaker (handsfree operation) so that a person nearby can talk to you via the built-in intercom.

The InterCom function must be permitted on the called system telephone (see manual of the telephone).

**Announcement via loudspeaker:** (only in combination with a door/switch module *COMmander 2TSM analog*) This function enables an announcement to a loudspeaker device or an active loudspeaker (e.g. ELA system in a department store or supermarket) connected to the audio output (Cinch jack marked with „audio output“) of the PBX. A previously configured internal telephone number is called from an internal telephone. The voice connection is established right after dialling the telephone number.

The internal number used here must be configured in COMset. Internal subscribers need to have the announcement authorization.

### Call an internal System Telephone via InterCom Function (Announcement/handsfree Operation)



 On the called system telephone the LED next to the handsfree operation/loudspeaker/hook key (COMfortel 1500/2500 and COMfort 1000/1200/2000 plus) or the middle LED (smar-tel-i on COM-mander Basic) glows and the connection is established after it rings once.

The announcement or the handsfree operation is limited to 120 seconds. After that the connection will be interrupted automatically unless the receiver of the system telephone will be picked up within this period. The InterCom function must be permitted on the called system telephone (see manual of the telephone).

### Make a Loudspeaker Announcement

				
internal dial tone		(for Direct Exchange Line Telephone only)	telephone number of the announcement output	announcement

**Call announcement loudspeaker**

 The internal number used here must be configured in COMset. Internal subscribers need to have the announcement authorization.

This function is only possible by using a door/switch/music module (not included in the extent of supply) on the COMmander Basic.

### Save Money and get Information away from Home

**Call Through:** This function enables the use of the Least Cost Routing of the PBX for e.g. the travelling sales man. To avoid high costs when making e.g. an international call with the mobile phone you can call the PBX first and you will be connected to the requested target by it. The function Call Through enables the post dialling of any telephone number.

The biggest savings can be achieved if the telephone number of the PBX has been selected as a favourite special telephone number (e.g. „TellyActive Local“ or „Partner & Family“) at the mobile phone provider.

The PBX has to be configured with the configuration program COMset as well as with the program COMtools telephone book.

**SMS function:** (only in combination with the system telephones COMfort 2000 and COMfort 1200) The PBX supports the sending and receiving of Short Messages (SMS) in the fixed network<sup>1</sup> together with the system telephones COMfort 1200 and 2000 (e.g. to inform a sales man about a new appointment). Sender or receiver can be other SMS compatible terminals in the fixed network (e.g. SMS equipped telephones) and mobile phones within the GSM network. With the system telephone you can comfortably write, read and modify the messages. It is even more comfortable with the program COMfort SMS bundled in the scope of delivery.

In the configuration program COMset at least one SMS telephone and the SMS call distribution has to be configured for the use of SMS functions.

The configuration of the telephone and the use of SMS functions are described in the manual of the system telephone.

### Start a Call Through Connection



				
	Call Through MSN	tone (1 s)	external telephone number with preceding area code (also out of the telephone book of the mobile telephone)	conversation

**Call external connection via PBX**

or  

Star and Short-Code Dial Number of the PBX

**Call external connection via PBX (via Short-Code Dial Numbers)**

or  

Star and internal telephone number of the telephone

**Call internal subscriber of the PBX**

or  

Star and internal telephone number of the group

**Call internal group of the PBX**

<sup>1</sup> currently available only in Germany, Austria and Luxembourg (the SMS centers described here are invalid for Austria and Luxembourg)

 For safety reasons: There is a time limit for outbound external Call Through calls in the PBX (1-99 minutes).

COMpact 2206 USB or COMpact 4410 USB: Only a single Call Through connection is possible at the same time.

If configured, the PBX will support Least Cost Routing for Call Through calls.

If the telephone number transmitted by the mobile telephone is not authorized for Call Through the caller will hear the busy tone. The numbers of the mobile phones used and authorized for Call Through, have to be entered in COMtools as Public Short-Code dialling numbers with

Call Through authorization. You can also configure in COMtools for each individual mobile phone number if Blocking numbers are used.

The Call Through MSN that was configured in the configuration program of the PBX, must be known to you.

The telephone numbers in the phonebook of mobile phones are most often entered with a plus (+) in front of the country code (e.g. +49). The PBX can accept and use this format.

For the call data management with the PC program COMlist the Short-Code Dialling Number of the Call Through user is stored in the column „project“.

## Call Groups (Teams)

The PBX is able to manage groups (teams) additionally to the internal subscribers. Subscribers can be members of multiple groups. These groups can be used in order to reach the internal subscribers of certain departments (e.g. support, marketing, sales).

A group has, like an internal subscriber, an internal number. Some settings are also handled similar to an internal subscriber. The call diversion (External and door) can be configured for groups. The group number can also be forwarded to an internal or external subscriber (group Call Forwarding).

Groups can internally be used or called the same way as single internal telephones in the following functions:

- Pick-up
- Call transfer
- Query/Transfer
- Call Through
- Destination number for a call forwarding
- Automatic Dialling/Alarm Call

**Log in/out:** Your membership in a group does not mean that you are always called when your group is called. If you do not like to be reachable via the group calling number for a certain time but only as an individual subscriber, you will be able to „log out“ of this group.

This way there are active and passive members of the group. This function can be important for members of service lines or call centers who do not like to be available for their customers around the clock. Group functionality is not available for a subscriber that is logged out, but only for a certain period. There are three different modes to log in:

- inbound + outbound
- only inbound
- only outbound

A subscriber which is member of several groups can be only be „logged in outbound“ in one single group at the same time. If he likes to get also the calls of the other groups in this case, he will be able to log in there as „inbound“. Therefore he will be in the call distribution of more groups for internal -, public exchange - and door terminal calls.

With „log in outbound“ into a certain group, the subscriber gets a number of features/authorizations of the group which will replace his own features/authorizations as an individual subscriber in case of outbound business calls:

- Exchange line authorization for business calls
- Activation of Blocking/Release numbers for business calls
- Short-Code Dialling authorization for business calls
- Calling number presentation for business calls
- Preferred exchange line for business calls

**Group call forwarding:** Thanks to the group Call Forwarding you are able to forward internal and external calls addressed to your group to other internal telephones or external connections. Consequently a person that is not member of this group and is not able to log in, is able to take these calls.

The group Call Forwarding makes it possible that somebody is always reachable under the group telephone number even when calls cannot be taken by members of the group.

There are different reasons for not taking a call, e.g. nobody is there for a short or longer period or all the telephones logged in are busy. So there are 4 different types of Call Forwarding: the „CF unconditional“, the „CF on busy“, the „CF on no Reply“ and the „CF if all subscribers are logged out“.

**Forward group „unconditional“:** If the members of the group are not reachable for a longer period and you like to avoid that calls to the group are unsuccessful, you will be able to forward the calls addressed to the group to the substitute's telephone.

**Forward group „on busy“:** If the telephones logged into a group are busy often and you like to avoid that calls are not answered, you will achieve it by switching on the „group Call Forwarding on busy“. Inbound calls will be forwarded unconditionally to another telephone (e.g. the reception for further transfers) if all the telephones logged in are busy.

**Forward group „on no reply“:** If you like to make sure that somebody takes the calls for one group at any time even if the group members logged in leave the room for a short time you will reach it by „group Call Forwarding on no Reply“. If none of the group members logged in is picking up within 20 seconds (configurable), the call will be forwarded to another telephone (e.g. reception).

**Forward group „if all Subscribers are logged out“:** If you like that the calls for one group e.g. are taken by the answering machine during the night, you will be able to forward the group „if all subscribers are logged out“ e.g. to an answering machine or a group of answering machines. Then the Call Forwarding has not to be set every night again but the members of the group have only to take care that they will be logged out at the end of a working day.

**Switch off all:** If you are not sure which kind of group Call Forwarding is active at the moment and like to make sure that each one is switched off, use this programming.

**Programming via an external telephone:** In case that you have already left your house and like to configure a forwarding, the group Call Forwarding is also programmable via an external telephone. You are in need of an analog DTMF telephone, an ISDN telephone with DTMF signalling or a DTMF sender. Besides this the PBX has to be configured correspondingly with the configuration program COMset.

 For each of the three Call Forwarding settings a different destination can be configured.

If the „CF on busy“ and „CF on no Reply“ are activated at the same time, both variants will be in use. Depending on the case - the telephone is

busy or nobody takes the call or all the members are logged out - the call will be forwarded perhaps even to different destination numbers.

If an „CF unconditional“ is activated in addition to a „CF on busy“ and/or a „CF on no Reply“, only the „CF unconditional“ is used that means the whole calls will be forwarded to the destination of the „CF unconditional“. In this case the other forwarding settings are ignored, but are still active in the background. As soon as the „CF unconditional“ is switched off, the other still active forwarding settings are used again.

To activate the group Call Forwarding there must be an authorization configured for the telephone via configuration program COMset. Besides this the subscriber that configures the Call Forwarding must be a member of the group to be forwarded.









If you set an internal telephone as forwarding destination, this one will need to have at least the partial exchange line access for forwarded external calls.

Do not mix up the group Call Forwarding and the MSN/DDI Call Forwarding. You can only forward external calls to your mobile phone or another external connection with an MSN/DDI Call Forwarding. A forwarding of internal calls or to internal calls is not possible. So if you like to prevent that internal calls are forwarded to your mobile phone, use the MSN/DDI Call Forwarding (see [chapter External Callers should always reach Somebody when calling your external Number \(MSN/DDI Call Forwarding\) on page 28](#)).























Only subscriber configured for a group with the configuration program COMset, will be able to „log in“ by telephone.

You can also log in/out comfortably with the help of the menu of the system telephone COMfortel 1500/2500 and COMfort 1000/1200/2000 plus.

**Log in/out as a Member of a Group if you are only Member of one Group**

						<b>Log in/out inbound and outbound into a Group</b>
telephone of the group member		public password	inbound and outbound	1: log in, 0: log out		
			<b>or</b>			<b>Log in/out inbound only into a Group</b>
				inbound only		
			<b>or</b>			<b>Log in/out outbound only into a Group</b>
				outbound only		

**Log in/out as a Member of a Group if you are Member of several Groups**

							<b>Log in/out inbound and outbound into a Group, log out of a Group</b>
telephone of the group member		public password	inbound and outbound	1: log in, 0: log out	internal number of the group (if you log in to several groups „outbound“ will be valid for the last group)		
							<b>Log in/out inbound only into another Group, log out of a Group</b>
telephone of the group member		public password	inbound only	1: log in, 0: log out	internal number of the group and hash		
			<b>or</b>				<b>Log in/out inbound only into all Groups, log out of all Group</b>
				hash for all groups (in which the subscriber is a member)			
							<b>Log in/out outbound only into another Group, log out of a Group</b>
telephone of the group member		public password	outbound only	1: log in, 0: log out	internal number of the group (if you log in to several groups „outbound“ will be valid for the last group)		



**Log out of all Groups**

If you try to „log in outbound and inbound“ into different groups, you will be only „logged in outbound“ in the last group tried. In the other groups you will be only „logged in inbound“.

**Log out all Members of a single Group**

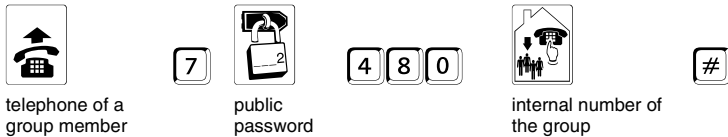

**Log out all Members of a single Group**

**Forward Group „unconditional“ to an internal/external Telephone because all Group Members are absent**

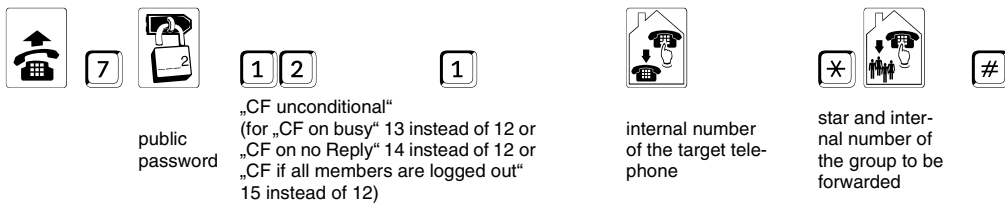

**Switch on group Call Forwarding with entry of an internal subscriber telephone number as destination**

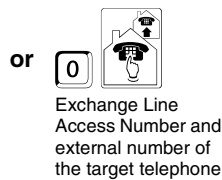

**Switch on group Call Forwarding with entry of an external telephone number as destination**

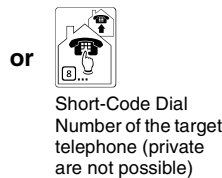

**Switch on group Call Forwarding with entry of a Short-Code Dial Number as destination**

If this kind of group Call Forwarding has to point always to the same destination telephone, the destination telephone number will have to be configured only once. Afterwards the Call Forwarding is just switched on or off.

These settings are configuration dependent.

**Forward Group „on Busy“ to an internal/external Telephone because all Telephones „logged in“ are currently Telephoning**

The „Forward telephone on Busy“ is configured similarly as described for the „CF unconditional“ above. The digits 1 2 only have to be

exchanged for 1 3 in order to switch on/off a „CF on busy“ instead of an „CF unconditional“.

**Forward Group „on no Reply“ to an internal/external Telephone because all Group Members are absent for a Moment**











The „Forward telephone on no Reply“ is configured similarly as described for the „CF unconditional“ previously. The digits 1 2 only

have to be exchanged for 1 4 in order to switch on/off an „CF on no Reply“ instead of an „CF unconditional“.

**Forward Group „if all Subscribers are logged out“ to e.g. an Answering Machine**

The „Forward telephone if all subscribers are logged out“ is configured similarly as described for the „CF unconditional“ previously. The digits 1 2 only have to be exchanged for 1 5 in order to switch on/off an „CF if all subscribers are logged out“ instead of an „CF unconditional“.

**Switch a previously configured Group Call Forwarding on/off**

public pass- word

„CF unconditional“  
(for „CF on busy“ 13 instead of 12 or  
„CF on no Reply“ 14 instead of 12 or  
„CF if all members are logged out“ 15 instead of 12)

star and internal number of the group to be forwarded

**Switch on group Call Forwarding without entry of a telephone number because number has already been saved**

or 

**Switch off group Call Forwarding**

**Switch off all active Call Forwarding Settings for one Group**









public password

internal number of the forwarded group

**Switch off all active group Call Forwarding settings for one group**

**Program Group Call Forwarding with an external Telephone if you are „Out of Office“**







external telephone

remote switching and programming MSN/DDI









tone (1 sec)

continue with DTMF

external password

external acknowledgement tone (1 sec continuous tone)

**Start external programming**

„CF unconditional“  
(for „CF on busy“: 13 instead of 12,  
„CF on no Reply“: 14 instead of 12,  
„CF if all members are logged out“:  
15 instead of 12)

internal number of the target telephone

star and internal number of the group to be forwarded

external acknowledgement tone (1 sec continuous tone)

**Switch on group Call Forwarding with entry of an internal subscriber telephone number as destination**



or



internal number of the target group

**Switch on group Call Forwarding with entry of an internal group telephone number as destination**

or

Exchange Line Access Number and external number of the target telephone







**Switch on group Call Forwarding with entry of an external telephone number as destination**

or



Short-Code Dial Number of the target telephone (private are not possible)

**Switch on group Call Forwarding with entry of a Short-Code Dial Number as destination**

„CF unconditional“  
(for „CF on busy“: 13 instead of 12,  
„CF on no Reply“: 14 instead of 12,  
„CF if all members are logged out“: 15 instead of 12)

star and internal number of the group to be forwarded

external acknowledgement tone (1 sec continuous tone)

**Switch on group Call Forwarding without entry of a telephone number because number has already been saved**



„CF unconditional“  
(for „CF on busy“: 13 instead of 12,  
„CF on no Reply“: 14 instead of 12,  
„CF if all members are logged out“: 15  
instead of 12)



star and internal number of the  
forwarded group



external  
acknowledgement  
tone (1 sec  
continuous tone)

### Switch off group Call Forwarding



internal number of  
the forwarded group



external acknowledgement  
tone (1 sec continuous tone)

### Switch off all active group Call Forwarding settings for a group

 You are in need of an analog DTMF telephone, an ISDN telephone with DTMF signalling or a DTMF sender.

The PBX needs to be configured for this operation with the configuration software COMset.

You need to know the remote switching and programming MSN/DDI and the external password that has been configured with COMset.

After starting the programming by calling the PBX and entering the external password, you will hear the external acknowledgement tone.

You will now be able to configure an MSN/DDI Call Forwarding. If the programming was successful, you will hear the external acknowledgement tone again. Now you can hang up the receiver or configure additional settings.

If you failed to enter the sequence in time or entered the wrong sequence, you will hear a busy tone. In this case hang up the receiver and start again.

## Hotel Functions for Reception and Room Telephones

(only *COMmander Basic* and *COMpact 4410 USB*) The hotel function enables the comfortable room and call data management if the PBX is used in a hotel. The scope of functions can be divided into three main areas.

**Hotel Reception Telephone:** (only in combination with a system telephone *COMfort 2000 plus* Xtension module) The hotel reception telephone enables various control and information functions via display and LEDs on the Xtension module. An additional PC is not necessary at the reception in many cases. The guests' Check in and Check out are directly controlled with the menu of the telephone. There are various functions available for the affected room in different phases.

Arrival of the guest (check in):

- View Room status (clean, uncleaned, blocked)
- Perform „check in“

During the guest's stay (after check in):

- Permit/block outbound calls from the room telephone
- Configure the wake-up time of the room telephones
- View guest information (e.g. accrued telephone charges, time of check in)
- Print informational invoices (of the currently accrued telephone charges) for the guest directly to a printer

The guest leaves:

- Perform „check out“
- Print invoice for the accrued telephone charges directly to a printer

The configuration of the function is described in the installation and configuration manual of the PBX.

The use of the hotel reception telephone is described in the manual of the system telephone.

**Hotel Room Telephones:** The PBX has many functions not making sense or being harmful if used from a hotel room telephone. This is the reason for blocking programming functions (like e.g. Do-not-disturb, Call forwarding) exchange functions and special exchange line access types. This way, the guest can only make outbound calls and accept calls and configure the personal wake-up time. In addition to this it is possible for the room service to configure the room status (clean, uncleaned, blocked) by entering a digit sequence.

The advantage of a system telephone *COMfort 1000*, *1200* or *2000* compared with the use of an analog or standard ISDN telephones is e.g. the remote controlled delete function when checking out the guest (privacy protection), the various comfort functions and specifically configured function keys. The functions which are still allowed for room telephones are handled the same way as described for normal telephones. With one exception: A programmable function key configured with the function „hotel room“ allows the setting of a wake-up time and the display of call charges and of the check in time. The following functions are also possible:

- Starting and accepting internal and external calls
- Delete lists and charges via the menu point „functions“ (the call charge meter of the PBX is not influenced)
- Interrogation of e.g. call charges via the menu point „information“
- Use of the caller/call/redial list as well as the telephone book (internal telephone number as well as the short-code dial numbers of the PBX are not listed in the telephone book)
- Sending and receiving of SMS
- Memo, scheduled call and Power Dialling
- Interrogation of call charges and setting of the wake-up time with a function key.

The configuration of the function is described in the installation and configuration manual of the PBX.

The use of the hotel room telephone is described in the manual of the system telephone.

**Print-out Function:** (available only in combination with a serial printer, the A4 printer EPSON LX300+ is recommended). This function enables the output of the accrued telephone charges as a guest invoice (or infor-

mational invoice) with a separate line for each call. This function is controlled by the hotel reception telephone.



The configuration of the function is described in the installation and configuration manual of the PBX.

 **Some providers do not transmit charge information. If a hotel guest is using such a provider to make outbound calls the accrued charges cannot be billed to him. Due to this reason it is not useful to activate Soft-LCR for a hotel room telephone. To avoid manual dialling of a provider these numbers should be added to the Blocking Numbers with COMtools tele-**

**phone book. The Blocking Numbers have to be activated for each hotel room telephone. Preconfigured standard files with Blocking numbers/Released numbers have been copied to your hard disk during the installation of COMtools. These may be imported into the COMtools telephone book with the button „CSV import“ in the window „Blocking Numbers“ or „Released Numbers“. The consistency of the files is not guaranteed.**

### Configure the Wake-up Time with the Room Telephone



4-digit entry of the time

**Configure a one-time Wake-up time**

 **If „0700“ was entered, you would receive a wake-up call at 7 o'clock in the next morning. Consequently the wake-up time has to be entered again for a new wake-up at the same time.**

**After a „check out“ the wake-up time is deactivated for the corresponding subscriber. Invalid entries will not delete an already valid wake-up time.**

### Delete the Wake-up Time with the Room Telephone



**Delete the Wake-up time**

### Enter the Room Status with the Room Telephone

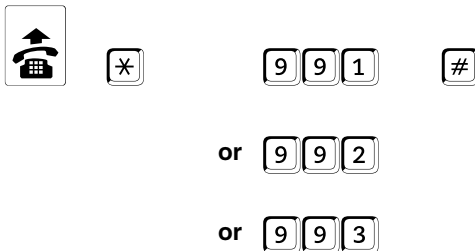

**enter room status „clean“**

**enter room status „uncleaned“**

**enter room status „blocked“**

Part of the product is a CD-ROM with various PC programs for use with the PBX. With the program *COMtools* separate PC programs can be launched. The programs can modify Wake-up times, Call Allowance accounts, Short-Code Dialling numbers, special numbers and the Music on Hold. The PC program *COMlist* will let you manage and analyse the data in the call data memory of the PBX. The PC program *Soft-LCR* manages the data for the automatic Least Cost Routing.



The data accessible by the PC programs *COMtools* can be protected with the user password (this password has to be configured with the configuration software first). An access to e.g. the call charge accounts will not be possible any longer without knowing the password. In order to read out the call data with *COMlist* the user password is absolutely necessary.

## Connection Options between PC and PBX

To use the bundled PC software, you have to establish a connection between your PC and the PBX. Four separate options are available for this purpose. The PC is directly connected to the serial interface (Pic. 1 and Pic. 2) or the USB interface (Pic. 4 on page 59) of the PBX, or a CAPI 2.0 compatible ISDN PC controller installed in the PC (Pic. 3 on page 59 and Pic. 5 on page 59) or a system telephone connected via USB with the PC (Pic. 6 on page 59; COMfort 1200/2000 or COMfortel 2500) used as an internal subscriber of the PBX. Depending on the connection option of your PC, please observe the following advises.

### Connection via serial Port (V.24)

In the PC program the V.24 COM Port of the PC (COM 1 to 4) connected to the PBX has to be selected under „Interface“. If problems occur during an ongoing transfer, they may be caused by faulty cable connections. Please contact the supervisor of the PBX.

### Connection via the USB Interface (only COMcompact 4410 USB and COMcompact 2206 USB)

In the PC program „USB“ has to be selected under „Interface“. The installation of the necessary driver is described in the enclosed CAPI manual.



In case of an indirect connection of the PC to the terminal to be configured (e.g. PC connection to the USB port of a COMfort 2000 to configure the PBX), the transmission will be faster if the interface is set to „ISDN controller (CAPI 2.0)“ (using the B channel) instead of the selection „USB“ (using the D channel).

### Connection via ISDN PC-Controller (CAPI 2.0)

In the PC program „ISDN controller (CAPI 2.0)“ has to be selected under „Interface“. The internal S<sub>0</sub> port connection of the ISDN PC-controller must have a programming permission. The default factory settings have permission for programming on every S<sub>0</sub> port. The subscriber number of the ISDN PC-controller must be configured to „ISDN PC-controller“ with the configuration program *COMset*. If you have problems with your ISDN PC-controller, please read the manual of your ISDN PC-controller or contact the vendor of the ISDN PC-controller directly about compatibility with CAPI 2.0. Try to get the most recent drivers with CAPI 2.0 support. Most vendors offer the option to download new drivers from the Internet or via mailbox.

If you encounter problems during a running transfer, please check your cabling. If necessary, contact your dealer or supervisor for help.

### Connection via a COMfort 1200/2000 or COMfortel 2500

In the PC program „USB“ has to be selected under „Interface“. The installation of the necessary driver is described in the manual of the telephone.

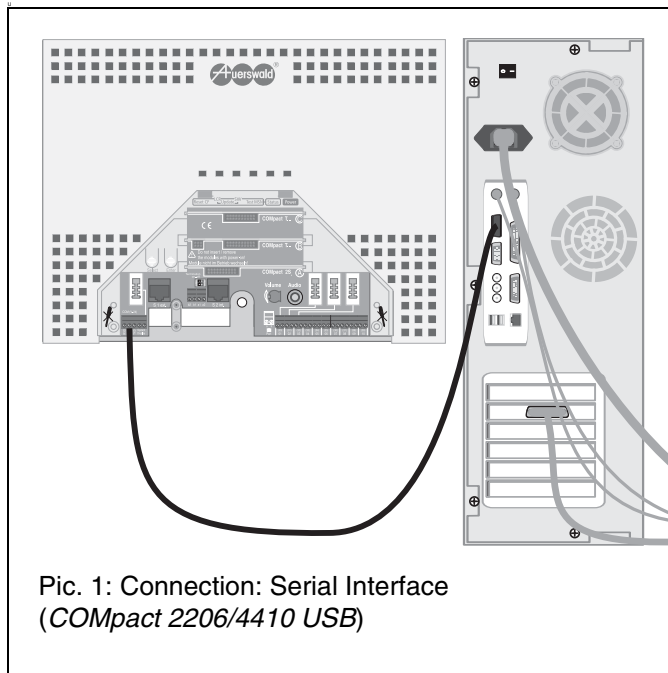

Pic. 1: Connection: Serial Interface  
(COMcompact 2206/4410 USB)

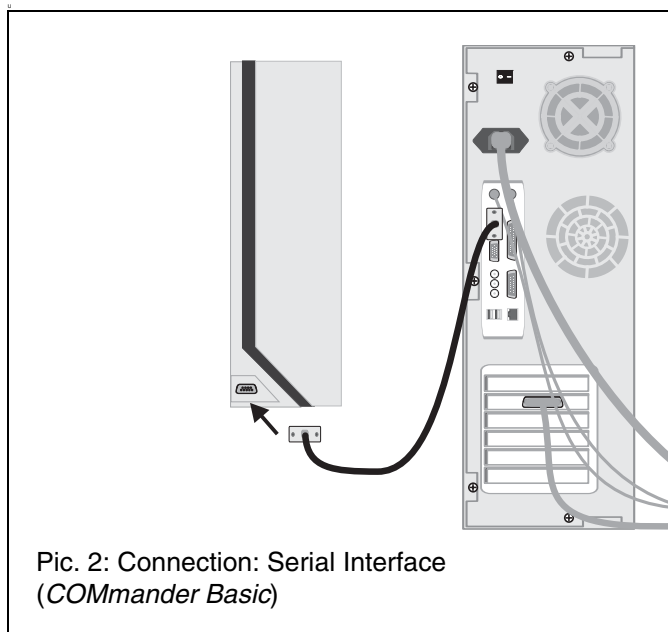

Pic. 2: Connection: Serial Interface  
(COMmander Basic)

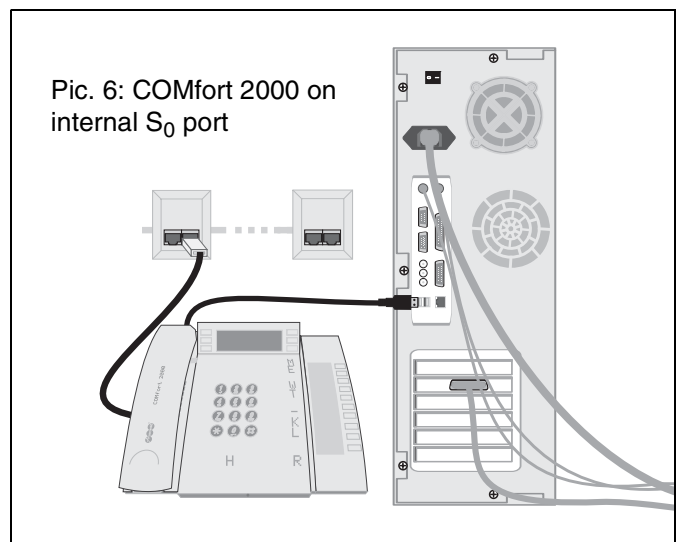
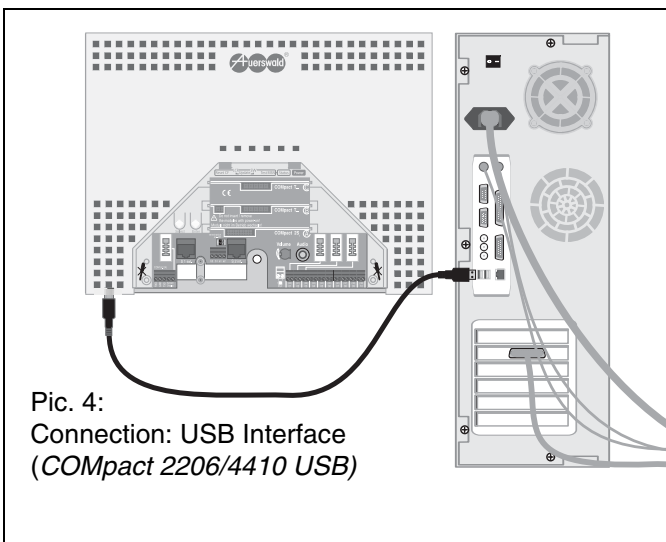
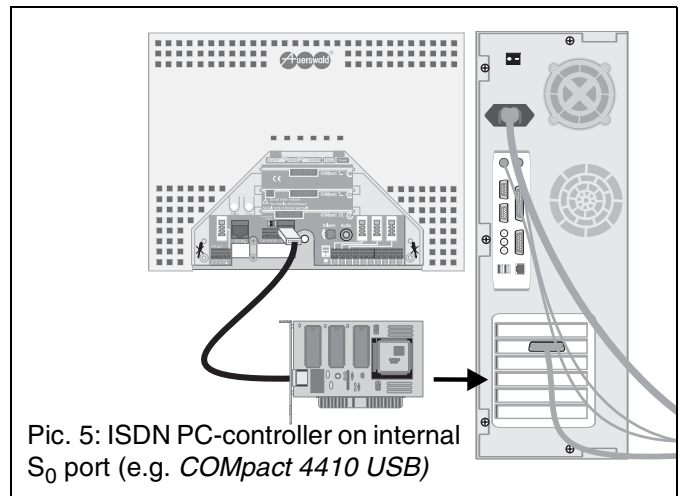
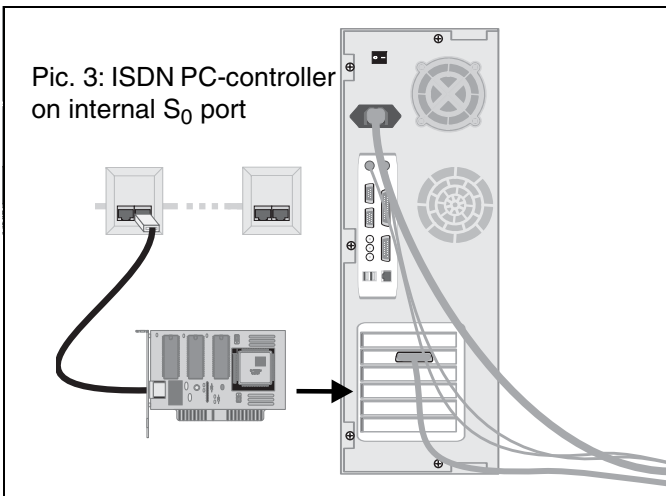

### Installation of the Software

- ① Insert the CD-ROM (Auerswald Mega Disk) into the CD-ROM drive.
- ② Sometimes the installation will not be started automatically. In this case you can start Setup manually: On your desktop click on the „Start“ button in the task bar and select „Run“. Click on „Browse“.
- ③ Open the CD-ROM drive with the Auerswald CD-ROM. Select the application „Setup“ in the root directory by double click. Then click on „OK“.
- ④ Follow the instructions on the screen. You will find the installation for programs under the software for the corresponding system.

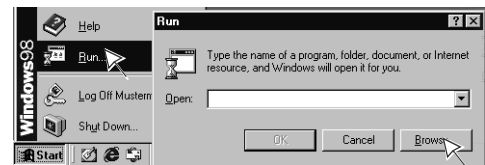

#### Minimum Requirements for the PC

- PC with Intel Pentium 266 MHz or compatible processor
- Operating system: Windows 98 SE, Windows 2000 (with service pack 4 or later), Windows XP (with service pack 2 or later), Windows NT 4.0 (with service pack 3 or later) but: no Windows NT 4.0 if you use USB interface
- RAM memory: 64 MB, 128 MB recommended for Windows XP: 128 MB, 256 MB recommended

- USB interface (if used) according to USB specification 1.1 or 2.0
- CD-ROM or DVD drive
- Mouse or compatible pointer device
- SVGA graphics board with 800 x 600 resolution, 1024 x 768 resolution and 65536 colours (16 Bit) recommended
- Available hard disk space for installation of *COMtools*: 8 MB, *COM-list*: 8 MB and *Soft-LCR*: 2 MB + 40 MB for the one-time installation of the *Java Runtime*

## Functionality of COMtools

The program *COMtools* is a launcher for separate PC programs to use with the PBX. You can select between:

- A Short-Code Dial Number editor. (You can enter the Short-Code Dial Numbers and special numbers described later),
- A program to manage the Wake-up times (See [chapter You like to use the Wake-up Function of the PBX on page 35](#)).
- A program to modify the Call Allowance accounts. You can also review the charge unit sums for the subscribers (see [chapter You like to control Call Charges on page 31](#)).
- A program for transfer of the internal Music on Hold, „Announcement before Answering“ and internal announcements (.wav file) into the PBX. You can also adjust the volume of the Music on Hold and adjust various other Music on Hold functions.

### Load Data and Store

Initially you should read the existing data from the PBX with the launched program. Then you will get a list of internal subscribers for telephone book, Wake-up times and Call Allowance accounts. You can now modify this transferred data from the PBX.

After you have modified the data file, you have to transfer these data back to the PBX. Additionally you can save the data to a file.

### Description of Short-Code Dial Numbers

The external telephone numbers that you often use can be saved under a four digit Short-Code Dial Number to simplify the dialling. This four digit Short-Code Dial Number will be dialled then instead of the Exchange Line Access Number 0 + external number. The PBX will dial automatically the Exchange Line Access Number and the stored number.

If you activate the Short-Code Dial authorization with *COMset* for single subscribers, these subscribers will be able to dial these Short-Code Dial Numbers without exchange line permission.

**User (private) Short-Code Dial Numbers:** Each subscriber can have up to twenty 20-digit numbers in the Short-Code number range 8200-8219. These numbers will only be available to the telephone used for programming. That means, you have to use the telephone for programming the private Short-Code Dial Numbers that will be used later to access these numbers.

**Emergency Short-Code Dial Numbers:** Enter Numbers as emergency Short-Code Dial Number that should be available for dialling to each subscriber with exchange line authorization. The permission to dial these numbers is part of each exchange line authorization. Mandatory entries for the numbers are e.g. the emergency numbers of the fire brigade and the police. The emergency numbers 110 and 112 are stored in the default factory setting under 8110 and 8112. To save time in a case of emergency, you can assign the entries in the emergency Short-Code Dial memory to 2 or 3 digit numbers (10-59; 100-599), e.g. with the number 110 (via configuration software *COMset*). The numbers 110 and 112 are assigned to 8110 and 8112 in the default factory settings. That means, if you dial 110 on your telephone, the PBX automatically dials the Short-Code Dial Number 8110 (Exchange Line Access Number 0 + external number 110). The advantage is that even persons without PBX experience or knowledge of Exchange Line Access Numbers can dial these numbers without any problems. You can store a maximum of 10 emergency numbers within a numbering range of 8110 to 8199.



*The emergency call priority function provides an exchange line at any circumstance for an emergency call or an alarm call to an external number. If all exchange lines are busy, an active call will be terminated in favour of the emergency call. Therefore, do not enter any „general“ Short-Code Dial Numbers here.*

**Long (100-digit) Short-Code Dial Numbers:** You can store a maximum of 10 long Short-Code Dial Numbers. You can choose from a numbering range of 8100 to 8109. In addition to a 20-digit dialling number you can enter a short text, to be sent to e.g. a pager (e. g. SCALL, D2-Message). Open the help file (Help...Topics) to view the character options you have.

**Public (common) Short-Code Dial Numbers:** You can store a maximum of 400 public Short-Code Dial Numbers. You can choose from a numbering range of 8600 to 8999. All subscribers with exchange line authorization have the permission to dial these numbers.



*The telephone book of a connected system telephone (COMfortel 1500/2500 and COMfort 1000/1200/2000 plus) is merged with the telephone numbers (with name) entered into the short-code dial number memory of the PBX. To use this function, the short-code dial numbers with name should be entered with the program *COMtools telephone book*.*

*With the program *COMtools telephone book* you can transfer some of the short-code dial numbers of the PBX into the telephone book of a connected system telephone COMfortel DECT 900 or COMfort DECT 800.*

*The numbers of the mobile phones used and authorized for Call Through, have to be entered in COMtools as **Public Short-Code Dial Numbers with Call Through authorization**. The number presentation of the mobile phone must be activated. You can also configure in COMtools for each individual mobile phone number if **Blocking Numbers** are used.*

### Description of special Numbers

**Blocking Numbers:** To limit the exchange line authorization of subscribers/groups, you can enter up to 20 10-digit Blocking numbers. These Blocking numbers can be activated for each individual subscriber/group with the configuration program *COMset*. It is common use to Blocking number with higher charges that are starting with a certain number and should not be accessible to every subscriber e.g. the 0900-numbers. The first 4 to 5 digits are significant for most high charge telephone services. Please keep in mind that all numbers beginning with the numbers entered here are blocked. For example: If you enter „0“ only, all long distance calls would be blocked.

**Release numbers:** To extend the exchange line authorization of subscribers/groups, you can enter up to 20 10-digit Release numbers. These Release numbers can be activated for each individual subscriber/group with the configuration program *COMset*. You can enter here e.g. the number „0800“ to be available for subscribers without exchange line authorization. The Release numbers have a higher priority than the blocking numbers, so you can deactivate Blocking numbers or parts of blocking numbers (e.g. block 0900 numbers but release 09001 numbers). Please keep in mind that all numbers beginning with the numbers entered here are released. For example: If you enter „0“ only, all long distance calls would be released.

**VIP numbers:** If you like to be reachable for special persons with your activated „Do-Not-Disturb“ service, it will be possible to enter their external telephone number into a VIP list with the PC software *COMtools*. This VIP list is valid for all subscribers and you are able to activate or deactivate it for your telephone if necessary (p. 30). The presentation of the caller telephone number is necessary for the PBX to recognize the caller. You can enter up to twenty 20-digit VIP numbers.

**Robinson numbers:** If you like not to be reachable for certain individuals, it will be possible to enter their external telephone number into a Robinson list with the PC software *COMtools*. This Robinson list is valid for all subscribers and you are able to activate or deactivate it for your telephone if necessary (p. 30). The presentation of the caller telephone number is necessary for the PBX to recognize the caller. You can enter up to ten 20-digit Robinson numbers. You are able to activate or deactivate it for groups with the configuration program *COMset*.

## Call Data Management with *COMlist*

The PC program *COMlist* helps you to manage and analyse the call data in the call data memory of the PBX. The call data from the PBX is transferred to a data base and stored on the hard disk. The capacity of the data base is limited only by the size of your hard disk.

### Update Data Base

To update your data base, select the menu „File...Read from PBX“. The data will be stored automatically after being transferred from the PBX. Already existing call data will be identified and will not be stored again. You can read data from the PBX at any time without generating double entries in the data base. Then you may delete the whole call data memory in the PBX with the menu „Edit...Delete call data in the PBX“ to make room for new call data.

With the menu „Edit...Display all call data“ you can view all data stored in the data base. If you do not like to keep all call data, you can delete the oldest calls until a certain date with „Edit...Delete old calls in the data base“.

### Description of the Filters

If you do not like to view or print all data transferred from the PBX, you can filter the data by the following criteria:

- Columns that should not be displayed;
- Call time frame and duration;
- Internal subscribers/groups involved in the call (selectable from an editable „subscriber/group list“);
- Type of call;
- S<sub>0</sub> port (exchange line), used for the call
- Project number if external calls have been assigned with project numbers.
- Called numbers (from a „called party list“, loaded and edited as e.g. a Short-Code Dial Number file) or provider (selectable from an editable „provider list“).

An assistance for the selection of these criteria is the usage of the base filter. If you like to filter the call data always according to the same criteria, the creation of one or more profile filters is recommended. Then you can use these profile filters for every file. The quick filter lets you filter internal subscribers and time frames with just two mouse clicks.

In addition to printing, you can also save the filtered data to a text file for further editing with other programs. The unfiltered data will always be saved automatically after transfer from the PBX.

## Least Cost Routing Software *Soft-LCR*

The PBX enables you to call easy and without prior thinking via the cheapest available network provider. This is called automatic Least Cost Routing. To activate LCR in the PBX, the function has to be configured and the current tariff structure of the network providers has to be stored in the tariff tables of the PBX. You are responsible for the latest updates of the tariff data.



*The function LCR must be activated for each individual subscriber (in *COMset* or via telephone; see p. 31).*

### Configure LCR with *Soft-LCR*

Start the PC program *Soft-LCR* and click on „new“. Open the register „Call-by-Call provider“. On this register card you can enter the prefix codes of the providers that you like to use for external calls and the prefix codes of the fallback providers.

Now open the register card „Area code number“ and enter your own city area code under „Area code“. Besides this you may enter the local area codes of your municipal zone (the local city codes up to 20 km distance) in this column. Then under the „Local zone area number“ you can enter the local area numbers of the distance from 20 to 50 km. The local area numbers for the different zones may be found in the Internet (e.g. under [www.billiger-telefonieren.de](http://www.billiger-telefonieren.de)).

Now open the register card „Special network service provider“. You may enter e.g. the name of different mobile phone networks here under „Name of the service provider“. In the second table the corresponding „Area codes“ of these providers are entered. In addition to this you may also enter certain number areas or local area numbers (e.g. 0180, 0190, 0700, 0800) as „Special network service provider“. Each of these provider names can be assigned to different Call-by-Call providers depending on the time of day.

Now open the day of the week register card one after the other (Monday - Friday, Saturday, Sunday, holiday) and select on which day and at which time the PBX should use the network providers entered in the Call-by-Call provider register card by you. The selection is done separately for the individual call destinations city (local call), regional, national (long distance call), international (international call) or certain special networks.

If you have finished all settings, save the data into the PBX. One minute later the LCR will be activated.



*If your selected main provider is not available, you could configure the PBX to use one of up to seven possible fallback providers. If a dialling via fallback provider is not possible either, the PBX will dial directly through your network provider.*

*Friends and Family: With this function you can enter up to 20 telephone numbers (complete or partial telephone numbers). These numbers are routed via your own providers and not controlled by the day/time schedule.*

*International: With this function you can enter special international country telephone numbers. These numbers are routed via your own providers and not controlled by the day/time schedule. If you like to have the providers controlled by the day/time schedule, you can also enter an international telephone number as „Special network service provider“.*

**Warning:**

Touching the voltage carrying conductors or connectors may be dangerous to life.

As soon as the device is connected to the 230 Volt socket dangerous voltages may be present in the device (e.g. ringer voltage).

- The case may only be opened by authorized personnel<sup>1</sup>.

- Installation work inside the open case as well as maintenance services involving the keys inside the case are only allowed to be executed by authorized personnel<sup>1</sup>.

1. Authorized personnel: These are persons that are trained for this purpose (e.g. certified electricians). They must have the necessary knowledge about the work in an area with potentially hazardous voltage. They must also have the knowledge about the latest electrical safety standards and requirements.

## Initialize Settings

Telephones with the correct authorization can activate Call Forwardings. The possible problem is that the Call Forwardings are forgotten later. With the following initialization functions, you will delete the settings that affect the call distribution. Please keep in mind that you are eventually deleting settings that need to be reconfigured later.



your telephone

7



public password

0 4 #

### Initializing Telephone Settings

(this function will reset the settings for subscriber Call Forwarding, Follow-Me, recalls, exchange line reservations, Automatic Dialling and Do-not-Disturb)



7



secret password

0 5 #

### Reset MSN/DDI Call Forwardings

(this function deletes all the MSN/DDI Call Forwardings)

## Call the Service Technician and ask for a Modification of the Configuration

If you like to have changes to the settings of your PBX to be made by your dealer later, it will not be necessary that a service technician comes to your home. The function remote programming enables a service technician, with help of the corresponding devices, to read the data out of the PBX or to reprogram during an external telephone connection. He needs your permission of course. And if you give your permission by dialling certain digits, the service technician will be able to do the remote diagnosis or the remote programming only for a short time frame.

### Remote Programming

- 1 The service technician explains to you by telephone what he will do with the configuration data of the PBX.
- 2 If you agree to the operations of the service technician, he will ask you to go to one of your subscriber telephones of your PBX and to dial the digits **99** or **R 99**. You open the PBX and the connected COMfort 2000 for remote programming or remote reading. Follow the instructions of your service technician.

If the service technician only reads the data out of the *COMfort 2000* first, a repetition of this procedure will be necessary to transfer the data later.

## Perform an automatic PBX Firmware Update



internal dial tone



7



secret password



acknowledgement tone

0 6 #



ringing tone (the PBX establishes a connection to the server.)



acknowledgement tone



**Start update**



wait 5 to 6 minutes (the PBX is transferring the new firmware from the server.)



telephone is ringing (up to 60 seconds)



acknowledgement tone



**Then wait for acknowledgement tone**

An update of the firmware of the PBX could be necessary or useful if there are functional problems or if new features are offered. Ask your dealer whether an update would be the solution to your problems. Or inform yourself on the latest news about the PBX software - on our homepage in the Internet.

The update is started with a programming sequence. If the update is executed via ISDN over the exchange line as described in the following, the PBX will establish a connection with a server in order to let the actual software be transferred. The settings of the PBX are not changed

of cause. The update is free of charge: Only the cost for the necessary telephone connection is charged to you. After finishing the update you will be called to be informed about success/failure.

 *If the procedure was shorter than 60 seconds, but you hear the acknowledgement tone, your PBX firmware was already up to date.*

*If you receive this information call and are listening to a busy tone instead of the acknowledgement tone, the update was unsuccessful. In this case, repeat the whole procedure.*

*If you listen to a busy tone instead of the acknowledgement tone after dialling 0 6 2, the server port is busy. Put the receiver on-hook and try again later.*

*You should better start the update in a non busy situation (e.g. after hours), because all calls are automatically disconnected by the PBX.*

*After a successful PBX software update existing LCR data may be deleted.*

## Request Firmware Version



public password

Output digit by digit (see example B: p. 8), followed by an acknowledgement tone

### Enquire firmware version via telephone

The version number of the software used in this PBX can be requested via system telephone (*COMfortel 1500/2500 and COMfort 1000/1200/2000 plus*), a connected system display SD-420 (special accessory) or via any internal telephone, as described here.

The version number is compounded by two digits and one letter (e. g. 1.2b) and is formatted to 4 digits for output to the phone:

- 1st digit: before the comma;
- 2nd digit: after the comma;
- 3rd and 4th digit: letter, e.g. a=01, b=02,..., z=26)

## How to connect the Telephones

### Connecting analog Devices

If you like to connect an additional device or to connect another device to a connection box e.g. a telephone instead of a fax machine, please contact your specialized dealer or the supervisor of your PBX. If you like to connect other telephones to the already existing and configured analog connections (e.g. replace a pulse dial telephone by a new DTMF telephone), please pay attention to the following: The analog subscriber connections enable the connection of most of the analog units with pulse dialling or dual-tone multi-frequency dialling (telephone, fax machine, modem, answering machine). Units with a DTMF dialling must have a FLASH key (so-called signal key R).

The connection plugs of telephones or Fax/TAM machines are put into the jacks marked with „F“, the plugs of all other devices are put into the jack marked with „N“.

If you pick up the receiver telephone after having plugged in a new telephone, please dial 7 and hang up. Thanks to this the PBX will learn the dialling mode.

If the new telephone has a dual-tone multi-frequency dialling, check whether the FLASH key was set and set the FLASH period as short as possible (see operation instruction of the telephone). Then you execute the programming described in the following. Subsequent to this the PBX has learned the exact duration of the FLASH time of your telephone. This is very important e.g. for the transfer or Query. Analog telephones that execute certain function via T-Net function key/menu are using a long FLASH (300 ms). Often an additional FLASH key is available. Configure this also to 300 ms and execute the following programming again.

### Connecting ISDN Devices

If you like to connect an additional device, please contact your specialized dealer or the supervisor of your PBX. If an S<sub>0</sub> bus is connected to the internal S<sub>0</sub> port, there are often more connecting boxes than units but you will need a new internal telephone number for the new device. This must be configured with the configuration program *COMset*.

Besides this the quantity of the units that can be operated on one S<sub>0</sub> port is limited. You are able to connect up to eight ISDN devices, a maximum of four of them without their own voltage supply (that applies to most of the ISDN telephones). If you like to replace one device by another (e.g. telephone by telephone or ISDN PC-controller by ISDN PC-controller), you will also have to pay attention to the fact that a maximum of four devices per S<sub>0</sub> port may get their voltage supply out of the PBX. All the devices should be certified Euro-ISDN units in order to guarantee a proper functionality.

The connecting cable of an ISDN device may have a maximum length of 10 m. It is equipped with a Western plug that you plug into the ISDN wall jack as shown in [Pic. 7](#). (If you like to unplug the Western plug out of the wall jack again, you will have to press the lever in order to remove it). In case of self powered ISDN devices you have to connect the power supply with the 230 Volt mains.

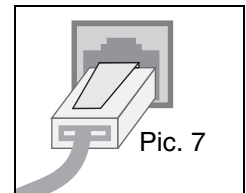

Then you must enter the MSN into the new unit (see instruction manual of the telephone). This MSN must match with an MSN configured with *COMset* for the internal S<sub>0</sub> port.



corresponding DTMF telephone

public password

press the Flash key twice

### Learn FLASH Time

## Cleaning of the Casing



**Liquids entering into the case may cause a mortal electric shock or a damage or destruction of the unit.**

**-When cleaning the case, make sure to prevent any liquid from dripping into the case.**

Protect the PBX against moisture, dirt, aggressive fluids or steam. Should a cleaning be necessary, wipe the case with a slight humid cloth or use an antistatic fabric.

## Frequent Problem Sources

The functional richness of the PBX makes it sometimes possible that a function is started unintentionally and by mistake (e.g. by dialling a wrong number sequence). It also is possible that you dialled an incorrect programming sequence and are starting a function that has an unknown effect to you.

Or you have no knowledge about the authorizations and permissions of the subscribers, which might be limited by the configuration program *COMset*.

Sometimes problems that are suspected to be in the PBX are actually problems located in the telephone (e.g. ringer switched off, no MSN entered). There might also be problems with power failures or the exchange lines.

The following chapters will assist you in finding minor problems yourself. If you are still not finding a solution here, please contact your dealer or the supervisor of the PBX.

### You are hearing an unexpected Tone

Various tones in the receiver are signalling various operating modes of the PBX (see [chapter Listen to internal Dial Tones on page 38](#)).

If you are in programming mode, you will hear e.g. the acknowledgement tone as a signal for entering the correct password or the end of a programming sequence.

The internal dial tone after picking up the receiver or after pressing the FLASH- or R-key is signalling that you can start to dial a number.

If you hear a different tone than expected and described in the programming description, most often a mistake in dialling or a missing authorization or permission is the reason. The following chapters will describe examples of these situations.

### You are not hearing a Dial Tone after Picking up the Receiver

- ① If you only have this problem with some internal telephones, please check the wiring and plugs. Please also check the telephone.
- ② If you only have this problems with single internal telephones, probably no internal telephone numbers were defined via configuration program.
- ③ If you only have this problem with some internal telephones, these might be configured as door phones with *COMset*. In this case, you are immediately connected with the door after picking up the receiver.
- ④ If this problem exists for system telephones (COMfortel 1500/2500 and COMfort 1000/1200/2000 plus) and if „invalid MSN“ is shown in the display when picking up the receiver, no or a wrong telephone number has been configured as MSN in the telephone. Enter an **internal** telephone number (from the range of numbers on the internal S<sub>0</sub> port) here.
- ⑤ If this problem exists for an internal ISDN telephone, perhaps no or a wrong telephone number has been entered as the 1st MSN in the telephone. Enter an **internal** telephone number (from the range of numbers on the internal S<sub>0</sub> port). Please note that this MSN has to be presented to the PBX by the telephone (see manual of the telephone).

- ⑥ Disconnect the telephone from the *PBX* for 5 seconds **and** an eventually existing external power supply (Pull the plug). If the problem is solved, the telephone had a malfunction.
- ⑦ If you have this problem with all internal telephones, check the power plug connection of the *PBX* or the possibility of a power failure.
- ⑧ If you have this problem with all internal telephones, disconnect the *PBX* from the external power supply (Pull the plug) for 5 seconds. If you hear the dial tone then, the *PBX* had a malfunction. If you are still not hearing the dial tone, please contact your dealer or supervisor of the *PBX*.

### You are hearing the internal Dial Tone on a Direct Exchange Line Telephone

- ① The dialling method of the telephone is unknown to the *PBX*. Dial a  and put the receiver on hook.

### You are hearing the Busy Tone after picking up the Receiver on a Direct Exchange Line Telephone

- ① All available public exchange lines are busy.

### You are hearing a pulsating Tone (Special Dial Tone) after Picking up the Receiver

- ① Eventually a subscriber Call Forwarding has been configured for the telephone. You can switch this function off, if unwanted.
- ② Eventually a do-not-disturb service has been configured for the telephone. You can switch this function off, if unwanted.
- ③ Please check, if the filling status of the call data memory has exceeded 80%. If possible, delete the call data memory entries.
- ④ Check, if the type of dial tone has been modified and reconfigure this modification, if unwanted.

### You are hearing a pulsating Tone (Special Dial Tone) for 2 seconds after Picking up the Receiver

- ① An automatic dialling has been configured for the telephone. You can switch this function off, if unwanted (see [p. 39](#)).

### You are hearing a pulsating Tone (Special Dial Tone) after logging into a Group

- ① Eventually a group Call Forwarding has been configured for the group. You can switch off this function, if unwanted (see [p. 55](#)).

### You are hearing a Clicking/Breaking after Picking up the Receiver

- ① If this is an analog telephone, the „call charge transmission immediately“ has been activated with the configuration program *COMset*. You will hear these charge unit pulses for the previous call after picking up the receiver (particularly, if it was an expensive long distance call). If your telephone is not able to display charges, this configuration may be obsolete.



- ② Check the curled cord of the receiver for defects.

### Telephoning impossible

The most important requirement for telephoning is the presence of a dial tone after picking up the receiver. If this is not the case, the previous chapter will help you.

If an external call is not possible with your telephone, please check, if this problem is also existing on other internal telephones or if dialling a different external number is possible.

#### No external Call possible

- ① If you have this problem only with some internal telephones, please check the exchange line authorization for these subscribers (configuration program *COMset*).
- ② If you have this problem only with some internal telephones, please check, if there is a call allowance configured for these subscribers and if the account is empty (see p. 32).
- ③ If this problem happens after the first power-on, please check, if your ISDN connection supports the necessary protocol (DSS1). Ask your network provider!
- ④ Please check the connection between the NT (NTBA or external S<sub>0</sub> bus) and the *PBX*.
- ⑤ Disconnect the *PBX* from the external power supply (Pull the plug) for 5 seconds. If the problem is solved, the *PBX* or the telephone had a malfunction.
- ⑥ You can check the function of the NT by directly connecting an ISDN telephone (If you have a Point-to-point ISDN line, the telephone must be compatible to the Point-to-point connection). If there is still no telephoning possible, disconnect the NT from the external power supply (Pull the plug) **and** the exchange line for 5 seconds. If the problem is solved, the NT had a malfunction. If the problem remains, contact your network provider for help.

#### Short-Code Dialling is not possible, external Calls are possible

- ① Eventually no number is stored under the dialled Short-Code number or the Exchange Line Access Number was added as a prefix (see p. 34).

#### Telephoning on the internal S<sub>0</sub> Port is not possible

- ① If you hear the busy tone after picking up the receiver, eventually both voice channels of the, internal S<sub>0</sub> ports are busy. Try again later.
- ② If this problem exists for system telephones (COMfortel 1500/2500 and COMfort 1000/1200/2000 plus) and if „invalid MSN“ is shown in the display when picking up the receiver, no or a wrong telephone number has been configured as MSN in the telephone. Enter an **internal** telephone number (from the range of numbers on the internal S<sub>0</sub> port) here.
- ③ Perhaps no or a wrong telephone number has been entered as the 1st MSN in the telephone. Enter an **internal** telephone number (from the range of numbers on the internal S<sub>0</sub> port). Please note that this MSN has to be presented to the *PBX* by the telephone (see manual of the telephone).
- ④ Disconnect the telephone from the *PBX* for 5 seconds **and** an eventually existing external power supply (Pull the plug). If the problem is gone, the telephone had a malfunction.
- ⑤ Disconnect the *PBX* from the external power supply (Pull the plug) for 5 seconds. If the problem is solved, the *PBX* or the telephone had a malfunction.

### The Telephone can not be called

Check if your telephone is really not reachable. Try to make a call from another internal telephone to your telephone.

#### No internal and external Calls

- ① Eventually a subscriber Call Forwarding has been configured for the telephone. You can switch this function off, if unwanted (see p. 25).
- ② Eventually a do-not-disturb service has been configured for the telephone. You can switch this function off, if unwanted (see p. 30).
- ③ Disconnect the telephone from the *PBX* for 5 seconds **and** an eventually existing external power supply (Pull the plug). If the problem is solved, the telephone had a malfunction.
- ④ Please check if the ringer is deactivated or defective.
- ⑤ Disconnect the *PBX* from the external power supply (Pull the plug) for 5 seconds. If the problem is solved, the *PBX* or the telephone had a malfunction.

#### No inbound external Calls, but Calls from internal Telephones are possible

- ① Eventually a MSN/DDI Call Forwarding has been configured. You can switch this function off, if unwanted.
- ② If you did not configure an external ringer rhythm with *COMset* for the telephone, no external calls are possible.
- ③ If you did not configure an (partial) exchange line access with *COMset* for the telephone, inbound external calls are not possible. Outbound external calls are also not possible in this case.
- ④ Please check the connection between the NT (NTBA or external S<sub>0</sub> bus) and the *PBX*.
- ⑤ Disconnect the *PBX* from the external power supply (Pull the plug) for 5 seconds. If the problem is solved, the *PBX* or the telephone had a malfunction.
- ⑥ You can check the function of the NT by directly connecting an ISDN telephone (If you have a Point-to-point ISDN line, the telephone must be compatible to the Point-to-point connection). If there is still no telephoning possible, disconnect the NT from the external power supply (Pull the plug) **and** the exchange line for 5 seconds. If the problem is solved, the NT had a malfunction. If the problem remains, contact your network provider for help.

#### No inbound Calls to the Group Number

- ① To receive calls to the group number, you have to log in as a group member „inbound“ (see p. 52).
- ② To be able to log into a group, your telephone has to be configured as member of the group with *COMset*.
- ③ Eventually a group Call Forwarding has been configured for the group. You can switch this function off, if unwanted (see p. 55).

#### No external Calls are reaching an internal Target Telephone with a Call Forwarding activated

- ① If you did not configure an (semi-restricted) exchange line access with *COMset* for the target telephone, inbound external calls are not possible. Outbound external calls are also not possible in this case.

## Query or Transfer not possible

### **Pressing the FLASH key disconnects the Caller**

- ① The FLASH duration of the telephone is too long. Modify the settings of the telephone (see manual of the telephone) or the settings of the PBX with the function „learn FLASH time“ (see p. 63).

### **Pressing the FLASH key leaves you in the first Call**

- ① The FLASH duration of the telephone is too short. Modify the settings of the telephone (see manual of the telephone) or the settings of the PBX with the function „learn FLASH time“ (see p. 63).
- ② The FLASH-key of your telephone is configured as EARTH-key and not as FLASH-key (see manual of the telephone).

### **A Query is not possible via T-Net-Function Key/Menu**

- ① Analog telephones equipped with T-Net-function keys or menus are using a long FLASH (300 ms). Eventually your PBX is not configured for this FLASH timing. Most of the time an additional FLASH-key is available at the telephone. Configure this key also for 300 ms (see manual of the telephone) and let the PBX learn the FLASH timing (see p. 63).

### **You try a Query from an external Call to an internal Call and hear the busy Signal**

- ① The called party is probably talking. Try again later.
- ② If you did not configure an (semi-restricted) exchange line access with COMset for the called telephone, a Query call from an external call would not be possible.

### **ISDN Telephone is ringing after putting the Receiver on-hook and you are reconnected**

- ① Please check with the manual of your telephone, if „Transfers on a PBX“ is activated. If not, try to correct this problem.

## Pickup is not possible

### **Busy Tone during Pickup for external Call**

- ① If you did not configure an (semi-restricted) exchange line access for business calls with COMset for the telephone, a Pickup of an external call is not possible.

### **Busy Tone during Pickup on the internal S<sub>0</sub> Port**

- ① Probably both voice channels of the internal S<sub>0</sub> ports are busy.

### **Pick-up takes over ongoing Calls to another Telephone**

- ① The Takeover function and Pickup use the same functional procedure. Switch off „conversation may be taken over“ via configuration program for all telephones. The permission for a Takeover is only useful for answering machines.

## You cannot identify Door Bell ringing

### **Door Bell rings with the Rhythm „1 x long“**

- ① Check whether the internal Call Forwarding from the Door Terminal for the corresponding telephone is switched on (configuration program of the PBX).

- ② Check whether the CLIP function with the Telekom door signal was switched on for the corresponding telephone (configuration program of PBX).

## PBX is not programmable

### **Busy Tone after entering the Password**

- ① Please check your password for correctness. If you forgot your setting password that you need for the access with the configuration program COMset, please contact the manufacturer. Functions that can be done with the public password are also possible with the secret password.

### **Programming with the PC is not possible**

- ① If you have this problem on the internal S<sub>0</sub> port, this port might be restricted for PC programming. Try again on a different S<sub>0</sub> port, if possible, or with the serial port.
- ② If you have this problem on the internal S<sub>0</sub> port, the ISDN PC-controller might eventually not present an MSN (as a workaround, you can configure with COMset a subscriber as „ISDN PC controller“ on the S<sub>0</sub> port). Try again on a different S<sub>0</sub> port, if possible, or with the serial port.

### **You can not program with one Telephone**

- ① Eventually the configuration of some functions (Call Forwarding, remote switching, manual configuration switching) or all functions are restricted for this telephone.
- ② If you configured a programming telephone, supervisor settings (with secret password) would only be possible from that telephone.
- ③ If the telephone has been configured as a Direct Exchange Line Telephone (no 0 to reach the public exchange), you have to press the little star key twice before programming.

## Error Messages for USB

### **Data/Status LED flashes orange**

- ① The connected PC switched into the suspend mode. Move the mouse connected to the PC.
- ② The USB port of your USB hub – if it exists – has been switched off. One reason for this are electromagnetic interferences near the USB hub. To eliminate this problem, there is an improved driver from Microsoft. You will find more information about this matter on the internet (English):

<http://support.microsoft.com/support/kb/articles/Q236/9/34.ASP>  
The necessary driver to eliminate this error for Windows 98 second edition (SE) can be ordered from Microsoft under the following telephone numbers:

Germany: 0180 5 67 22 55

Austria: 01 50222 22 55

Switzerland: 0848 80 22 55

You have to order a hotfix for the USB problem Q236934 and then you will get the new driver usbhub.sys by Microsoft.

## Telephoning

### Alarm -> page 22



Confirm alarm within 60 seconds with DTMF digit „0“

### Announcement/Handsfree mode -> page 50



Call System Telephone for InterCom Announcement



Call System Telephone for InterCom/Handsfree Mode



Call Audio Output

### Call Through -> page 52



Call external connection through PBX



Call external connection through PBX (using Short-Code Dial Number)



Call internal subscriber of the PBX



Call internal group of the PBX

### Conference -> page 20



Finish Conference Call completely

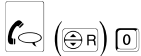

Connect both Conference calling Partners

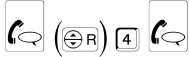

Finish Call with the 1st calling Partner (was in the background before Conference)

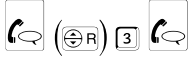

Finish call with the 2nd calling Partner (was in a Query before Conference)

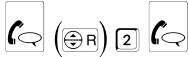

Back to Alternation – Put 1st calling partner into the background (same Condition as before Conference)

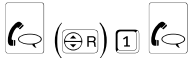

Back to Alternation – Put 2nd calling Partner into the Background (before Conference in a Query call)



Finish Conference Call completely

### Door Terminal Call -> page 21



Accept door terminal call within 30 seconds (configurable)



Call door terminal



Start internal Query call to call door terminal

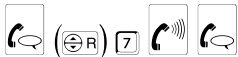

Open the door during door terminal Call

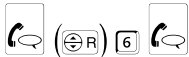

Finish door terminal call and switch to the other door terminal

### Park a Call -> page 16

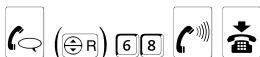

Park a Call in the Public Exchange

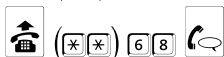

Unpark a Call

### Start a call -> page 11 and page 49



Call internal Telephone



Call external Telephone via Exchange Line Access Number „0“



Call external Telephone via Short-Code Dialling Number



Start external Call with Number Presentation restricted

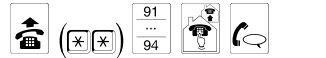

Start external Call with Exchange Line Selection (1st to 4th Exchange Line)



Start external Call with private Exchange Line Access

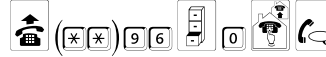

Start external Call with project assignment

### Start a call (on Busy/on no Reply) -> page 12



Cancel Query on no Reply by dialling the number „1“



Start Recall on no Reply (internal only)



On Busy: Reserve Exchange Line for the next Call



Start Recall on Busy (internal/external)



Start Priority Call to internal telephone with Do-Not-Disturb function enabled

### Start a call (Query) -> page 15

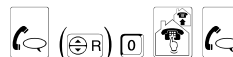

Start external Query



Start internal Query

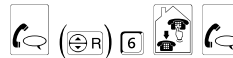

Another internal Telephone rings – Pickup

### Take a call -> page 10



Another internal Telephone rings – Pickup

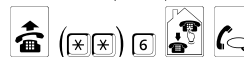

Take Call from Answering Machine



Accept waiting Call for conversation (the start Query)



Reject waiting Call to continue ongoing Call undisturbed

### Transfer and Alternation -> page 16



Connect both Call Partners by hanging up



Finish active Call and return to the Conversation with the Partner on Hold in the Background



Talking alternately with both Partners (Alternation)



Start internal Call and hang up (Blind Transfer)

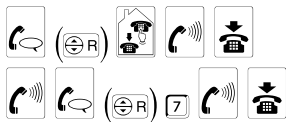

Start internal call during an external call and hang up (**Open Query**)

Put the external caller into the Waiting Loop if Transfer was unsuccessful



Transfer external caller to external Telephone (External to External Transfer)

Calling an internal third Calling partner and transfer to the second calling Partner.

## Settings

### Alarm -> page 43 and page 47

- 7 1111 6 9 1 # Activate Alarm input for one Alarm
- 7 1111 6 9 2 # Activate Alarm input for multiple Alarms
- 7 1111 6 9 0 # Deactivate Alarm input
- 7 1111 4 4 2 # \* Start programming via an external Telephone ...
- 6 9 1 # ... and activate Alarm input for one Alarm
- 6 9 2 # ... and activate Alarm input for multiple Alarms
- 6 9 0 # ... and deactivate Alarm input
- 7 1111 4 4 2 # \* Record Alarm Announcement and save it (COMpact 4410 USB and COMmander Basic only)
- 7 1111 4 6 6 # Listen to stored Alarm announcement

### Announcement before Answering -> page 48

- 7 1111 4 4 3 # \* Record Welcome Message „Announcement before Answering“ and store it
- 7 1111 4 6 7 # Listen to stored Welcome Message

### Automatic Dialling (BabyCall) -> page 39

- 7 1111 1 9 1 # Switch on Automatic Dialling by entering an internal telephone number as target.
- 7 1111 1 9 1 # Switch on Automatic Dialling without entry of telephone number because number has already been saved.
- 7 1111 1 9 0 # Switch off Automatic Dialling (start dialling within 2 seconds).

### Automatic Reception -> page 48

- 7 1111 2 3 0 # Activate/Deactivate Automatic Reception.

### Call Allowance and Call Charges -> page 31

- 7 1111 9 3 0 # Switch on or off Automatic Least Cost Routing.
- 7 1111 7 4 \* 0000 ... 9998 # Limit the Call Allowance to a certain number (0000...9998) of units.
- 7 1111 7 4 \* 9 9 9 9 # Set the Call Allowance to „unlimited“.
- 7 1111 7 3 \* 0000 ... 9998 # Increase the Call Allowance by a certain quantity of units (0000...9998).
- 7 1111 7 2 # Enquire level of Call Allowance account of single subscriber.

### Call Charge Data -> page 32

- 7 1111 7 2 # Enquire status of Call Allowance Account.
- 7 1111 7 1 # Enquire Call Charges accumulated for the phone.
- 7 1111 7 1 # Enquire the call charge sums of single subscribers.
- 7 1111 7 0 # Delete Call Charge sums of single subscribers.
- 7 1111 5 0 1 # Start or stop Call Charge Data printout
- 7 1111 5 1 \* 0 # Instruction to print the Call Charge Data of a single subscriber's calls.
- 7 1111 5 1 \* 1 # Instruction of printing the Call Charge Data of a single subscriber's business calls.
- 7 1111 5 1 \* 2 # Instruction of printing the Call Charge Data of a Subscriber's private calls.
- 7 1111 5 2 # Delete all Data out of the Call Charge Data Memory.
- 7 1111 8 6 0 # Select operation mode „No special functions“
- 7 1111 8 6 1 # Select operation mode „Selection via PC with ATD command“
- 7 1111 8 6 2 # Select operation mode „Continuous Call Data output“
- 7 1111 8 6 3 # Select operation mode „Data exchange with external programs“
- 7 1111 8 6 4 # Select operation mode „D-channel protocol output in ASCII format“
- 7 1111 8 6 5 # Select operation mode „D-channel protocol output in binary format“
- 7 1111 8 6 6 # Select operation mode „TAPI Mode“

### Call Forwarding (Subscriber), Follow-me -> page 25

- 7 1111 1 2 1 # Immediately<sup>a)</sup> switch on Subscriber Call Forwarding with entry of internal telephone number as destination.
- 7 1111 1 2 1 # Immediately<sup>a)</sup> switch on Subscriber Call Forwarding without telephone number entry because it has already been saved.
- 7 1111 1 2 0 # Immediately<sup>a)</sup> switch off Subscriber Call Forwarding.
- 7 1111 2 0 # Switch off all Subscriber Call Forwardings on the telephone.
- 7 1111 2 5 # Switch on Follow-me on target telephone.
- 7 1111 2 5 0 # Switch off Follow-me on target telephone.
- 7 1111 4 4 2 # Start programming from external telephone... .



... and immediately<sup>a)</sup> switch on Subscriber Call Forwarding with entry of an internal telephone number as target.



... and immediately<sup>a)</sup> switch on Subscriber Call Forwarding without telephone number entry because it has already been saved.

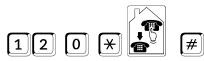

... and switch off Subscriber Call Forwarding immediately<sup>a)</sup>.



... and immediately switch off all active Subscriber Call Forwardings on the phone.

a) Please use in the digit sequences 13 instead of 12 for „CF on busy“ or 14 instead of 12 for „CF on no reply“.

**Call Forwarding (Group) -> page 52**



Immediately<sup>a)</sup> switch on Group Call Forwarding with entry of internal telephone number as target.



Immediately<sup>a)</sup> switch on Group Call Forwarding without entry of telephone number because it has already been saved.



Immediately<sup>a)</sup> switch off Group Call Forwarding.

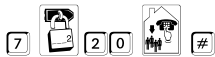

Switch off all Group Forwarding Calls valid for one group.



Start programming via an external telephone...



Immediately<sup>a)</sup> switch on Group Call Forwarding with entry of an internal telephone number as target.

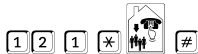

Immediately<sup>a)</sup> switch on Group Call Forwarding without entry of telephone number because it has already been saved.



Immediately<sup>a)</sup> switch off Group Call Forwarding.



Switch off all active Group Call Forwardings for one group.

a) Please use in the digit sequences 13 instead of 12 for „CF on busy“ or 14 instead of 12 for „CF on no reply“.

**Call Forwarding (MSN/DDI) -> page 28**

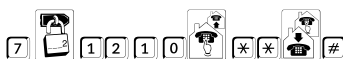

Immediately<sup>a)</sup> switch on MSN/DDI Call Forwarding with entry of an external telephone number (with Exchange Line Access Number) as target.

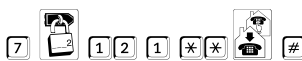

Immediately<sup>a)</sup> switch on MSN/DDI Call Forwarding without entry of telephone number because it has already been saved.

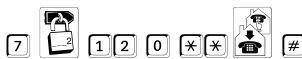

Immediately<sup>a)</sup> switch off MSN/DDI Call Forwarding.

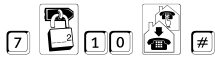

Switch off all Call Forwardings being active for these MSN/DDI.



Start programming via an external telephone ...



... and immediately<sup>a)</sup> switch on MSN/DDI-Call Forwarding with entry of external telephone number (with Exchange Line Access Number) as destination.



... and immediately<sup>a)</sup> switch on MSN/DDI Call Forwarding without entry of telephone number because it has already been saved.



... and immediately<sup>a)</sup> switch off MSN/DDI Call Forwarding.



... and switch off all active Call Forwardings this MSN/DDI.

a) Please use in the digit sequences 13 instead of 12 for „CF on busy“ or 14 instead of 12 for „CF on no reply“.

**Call Waiting -> page 24**

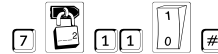

Knocking (Call Waiting) is permitted or forbidden.

**Configurations (Day, Night etc.) -> page 23**



Next setting will be valid for configuration 1...6.



Next setting will be valid for all configurations.



Next setting will be valid for current configuration.

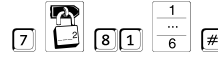

Set configuration 1...6 manually.

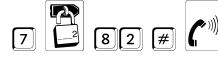

Enquire active configuration.

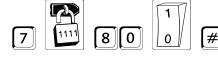

Switch on or off the time controlled switching of the configurations.

**Do-not-disturb -> page 30**

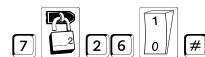

Switch on or off Do-not-disturb.

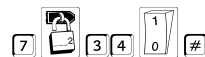

De/Activate VIP list.

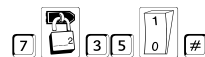

De/Activate Robinson list.

**Door Terminal Call -> page 41**



Enter external telephone number as destination of the Door Terminal Call.



Switch on or off External Door Terminal Call.

**Firmware Update -> page 62**



Start Update



Then wait for acknowledgement tone

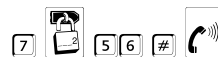

Request Firmware Version

**Flash-Time -> page 63**



Learn Flash-time

**Groups -> ab page 52**

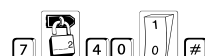

As a Group Member – Login as inbound and outbound / logout from Group.

- 7 4 1 0 # As a Group Member – Login as inbound only / logout from Group.
- 7 4 2 0 # As a Group Member – Login as outbound only / logout from Group.
- 7 4 0 0 # As a Member of multiple Groups – Login as inbound and outbound / logout from Group.
- 7 4 1 0 # As a Member of multiple Groups – Login into an additional group as inbound only / logout from Group.
- 7 4 1 0 # As a Member of multiple Groups – Login into all groups as inbound only / logout from all Groups.
- 7 4 2 0 # As a Member of multiple Groups – Login into one group as outbound only / logout from that Group.
- 7 4 0 0 # Logout of all Groups.
- 7 4 8 0 # Logout all members of a Group.

**Hotel Room Telephones (Hotel Function) -> page 57**

- \* 2 3 0 # Configure the wake-up time for a one-time wake-up call.
- \* # Delete a wake-up time.
- \* 9 9 1 # Enter the room status „clean“.
- \* 9 9 2 # Enter the room status „unclean“.
- \* 9 9 3 # Enter the room status „blocked“.

**Initialize Settings -> page 62**

- 7 0 4 # Initialize Telephone
- 7 0 5 # Initialize external numbers

**Music on Hold -> page 44**

- 7 4 3 # \* # Record Music on Hold and store it
- 7 4 4 1 # \* # Record Music on Hold/Announcement and store it (COMmander Basic only)
- 7 4 5 0 # Switch off Music on Hold and Announcement
- 7 4 5 1 # Switch on Announcement (without Music on Hold)
- 7 4 5 2 # Switch on internal Music on Hold (without Announcement)
- 7 4 5 3 # Switch on internal Music on Hold mixed with Announcement
- 7 4 5 4 # Switch on External Music on Hold (without Announcement)
- 7 4 5 5 # Switch on External Music on Hold mixed with Announcement
- 7 4 9 0 # # Select self-recorded or pre-recorded .wav-File as internal Music on Hold and listen to it (COMpact 4410 USB only)
- 7 4 9 1 # # Select „American Patrol“ as internal Music on Hold and listen to it (COMpact 2206/4410 USB only)
- 7 4 9 2 # # Select „Carmen“ as internal Music on Hold and listen to it (COMpact 2206/4410 USB only)

- 7 4 9 3 # # Select „For Elise“ as internal Music on Hold and listen to it (COMpact 2206/4410 USB only)
- 7 4 9 4 # # Select „The Entertainer“ as internal Music on Hold and listen to it (COMpact 2206/4410 USB only)
- 7 4 9 5 # # Select „Menuett: L. Boccherini“ as internal Music on Hold and listen to it (COMpact 2206/4410 USB only)
- 7 4 9 6 # # Select „Menuett: G. Ph. Telemann“ as internal Music on Hold and listen to it (COMpact 2206/4410 USB only)
- 7 4 9 7 # # Select „Menuett: Puccini“ as internal Music on Hold and listen to it (COMpact 2206/4410 USB only)
- 7 4 7 1 0 # # Set Pause Length from 0 to 30 seconds for the Music on Hold Announcement
- 7 4 6 1 # # Listen to Announcement (without Music on Hold)
- 7 4 6 2 # # Listen to internal Music on Hold (without Announcement)
- 7 4 6 3 # # Listen to internal Music on Hold mixed with Announcement
- 7 4 6 4 # # Listen to external Music on Hold (without Announcement)
- 7 4 6 5 # # Listen to external Music on Hold mixed with Announcement

**Number presentation -> page 24**

- 7 9 2 0 # Switch on or off number presentation.
- (\* \*) 6 6 9 0 # # Start single call without number presentation.

**Parking Code -> page 47**

- 7 8 8 0 1 # # Enter Code Digits
- 7 8 8 0 0 # # Delete Code Digits

**Private Password -> page 50**

- 7 3 8 # Change private password – enter old private password once and new private password twice.

**Remote Switching Relay -> ab page 41**

- 7 6 1 0 # # Switch on or off 1st Relay (COMpact 2206/4410 USB: „TS“ on slot B, COMmander Basic: „TS11/TS12“)
- 7 6 2 0 # # Switch on or off 2nd Relay (COMpact 2206/4410 USB: „TO“ on slot B, COMmander Basic: „TO11/TO12“)
- 7 6 3 0 # # Switch on or off 3rd Relay (COMpact 2206/4410 USB: „REL“ on slot B, COMmander Basic: „REL3 com/no/nc“)
- 7 6 4 0 # # Switch on or off 4th Relay (COMpact 4410 USB: „TS“ on slot C, COMmander Basic: „TS21/TS22“)
- 7 6 5 0 # # Switch on or off 5th Relay (COMpact 4410 USB: „TO“ on slot C, COMmander Basic: „TO21/TO22“)
- 7 6 6 0 # # Switch on or off 6th Relay (COMpact 4410 USB: „REL“ on slot C, COMmander Basic: „REL6 com/no“)
- # # Start programming via an external Telephone ...

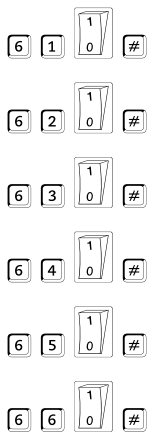

... and switch on or off 1st Relay  
(COMpact 2206/4410 USB: „TS“ on slot B,  
COMmander Basic: „TS11/TS12“)

... and switch on or off 2nd Relay  
(COMpact 2206/4410 USB: „TO“ on slot B,  
COMmander Basic: „TO11/TO12“)

... and switch on or off 3rd Relay  
(COMpact 2206/4410 USB: „REL“ on slot B,  
COMmander Basic: „REL3 com/no/nc“)

... and switch on or off 4th Relay  
(COMpact 4410 USB: „TS“ on slot C,  
COMmander Basic: „TS21/TS22“)

... and switch on or off 5th Relay  
(COMpact 4410 USB: „TO“ on slot C,  
COMmander Basic: „TO21/TO22“)

... and switch on or off 6th Relay  
(COMpact 4410 USB: „REL“ on slot C,  
COMmander Basic: „REL6 com/no“)

**Ringer Rhythms -> page 38**

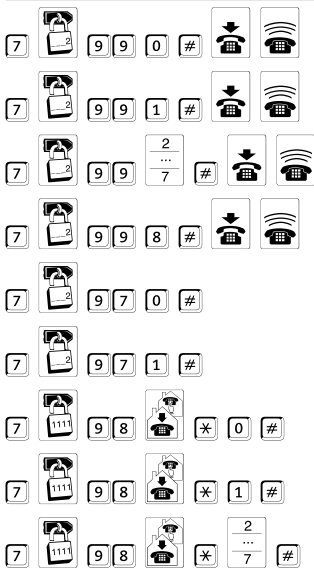

Listen to Ringer Rhythm 1 x long.

Listen to Ringer Rhythm 3 x short.

Listen to Special Rhythm 1 ... 6.

Listen to Alarm Call.

Select Ringer Rhythm 1 x long for internal Calls.

Select Ringer Rhythm 3 x short for internal Calls.

Configure ringer rhythm „1 x long“ for external calls

Configure ringer rhythm „3 x short“ for external calls

Configure special rhythm „1...6“ for external calls

**Room Monitoring -> page 40**

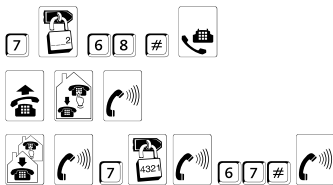

Start Room Monitoring to listen into the room later.

Call configured telephone from internal telephone and perform Room Monitoring.

Perform Room Monitoring from an external telephone.

**Short-Code Dial number -> page 34**

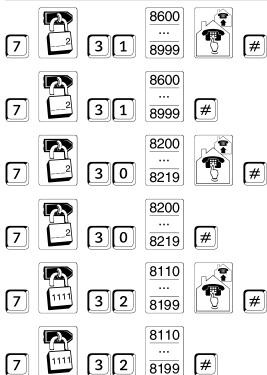

Enter telephone number into the public Short-Code Dial Number memory.

Delete telephone number from the public Short-Code Dial Number memory.

Enter telephone number into private Short-Code Dial memory.

Delete telephone number from the private Short-Code Dial memory.

Enter telephone Number into the Emergency Short-Code Dial Memory

Delete Telephone Number from the Emergency Short-Code Dial Memory

**Time and Date -> page 47**



Set Time

Set Date

**Tones -> page 37**

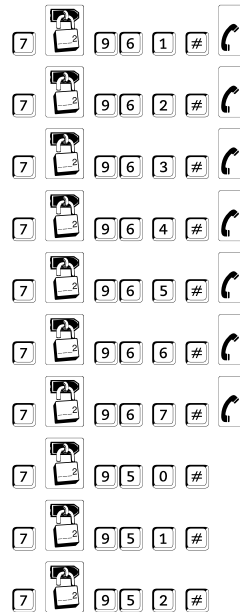

Listen to Continuous Dial Tone.

Listen to Extension Dial Tone.

Listen to Confirming Tone.

Listen to Busy Tone.

Listen to Special Dial Tone.

Listen to Ringing Tone.

Listen to Knocking Tone.

Select Continuous Dial Tone as internal Dial Tone.

Select Extension Dial Tone as internal Dial Tone.

Select Special Dial Tone as internal Dial Tone.

**Wake-up Function -> page 35**

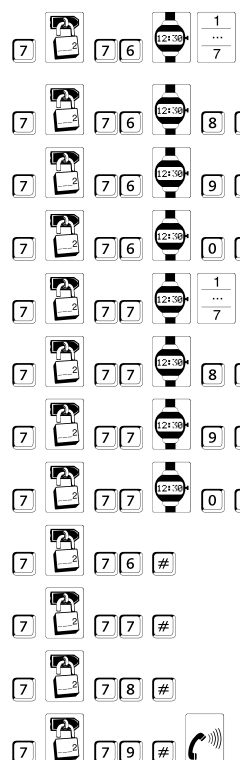

For single Wake-up – e. g. for 1:Set Wake-up time for Mo and activate for the first possible Wake-up time.

For single Wake-up – Set Wake-up for Sa and So and activate for the first possible Wake-up time.

For single Wake-up – Set Wake-up for Mo, Di, ..., Fr and activate for the first possible Wake-up time.

For single Wake-up – Set Wake-up for Mo, Di, ..., So and activate for the first possible Wake-up time.

For repetitive Wake-up – e. g. for 1: Set and activate Wake Up for each Mo.

For repetitive Wake-up – Set and activate Wake-up for each Sa and So.

For repetitive Wake-up – Set and activate Wake-up time for each Mo, Di, ..., Fr .

For repetitive Wake-up – Set and activate Wake-up for each day.

Activate one Wake-up without time because time has already been saved.

Activate repetitive Wake-up without time, because time has already been saved.

Switch off Wake-up.

Enquire Wake-up time.

**A**

<b>Abbreviations</b> .....	2
for call data .....	32
<b>Access Number</b>	
exchange line .....	11
external to external transfer .....	18
private exchange line access .....	49
project assignment .....	50
<b>Alarm</b>	
activate .....	43
record announcement .....	47
sequence .....	43
<b>Alternation</b> .....	21
from conference .....	21
from Query .....	19
<b>Analog Telephones</b>	
connection .....	63
differences in usage .....	9
<b>Answering Machine</b>	
for group if all logged out .....	54
Takeover of a call .....	10
<b>Auerswald Box</b> (selecting exchange lines) .....	12
<b>Authorization</b>	
allow call waiting .....	24
<b>Automatic Configuration Switching</b>	
activation .....	24
<b>Automatic Dialling</b>	
special dial tone .....	38
switching on .....	39
<b>Automatic Recall on Busy</b>	
in the public exchange .....	14
internal calls .....	14
<b>Automatic Reception</b>	
de/activate .....	48

**B**

<b>Blind Transfer</b> .....	17
<b>Blocking Numbers</b> .....	60
<b>Boss/Secretary Function</b> .....	48
<b>Business Call</b>	
starting .....	11
<b>Busy Tone</b> .....	13

**C**

<b>Call</b> .....	10
accept .....	10
alternation .....	19
blind transfer .....	17
make external .....	11
make internal .....	11
parking on the external S <sub>0</sub> port .....	16
parking on the Point-to-Multipoint connection .....	16
pickup other .....	16
retrieve parking .....	16
start with short-code dial number .....	12
suppress number presentation .....	12
Takeover .....	10
transfer both calling partners .....	20
transfer in a query .....	19
transfer to an unknown target .....	17
transfer to third call partner .....	18
transfer with prior notice .....	17
with project assignment .....	50
with short-code dial number .....	12
with two call partners at the same time .....	20
<b>Call Allowance</b>	
configure .....	31
enquire status .....	32
<b>Call Charges</b>	
Call Through .....	51
<b>Call Data</b>	
abbreviations .....	32
analyse .....	61
continuous printing (start/stop) .....	33
continuous printing start/stop .....	33
delete memory .....	33
printing on demand .....	33
registration .....	32
special dial tone filling status .....	38
<b>Call Data Export</b>	
continuous .....	33
start/stop .....	33
<b>Call Data Memory</b>	
delete .....	33
deleting .....	33
printout .....	33
<b>Call Data Printing</b>	
start/stop command .....	33
<b>Call data printing</b>	
operation mode of the serial interface .....	34
<b>Call Door Terminal</b> .....	22
<b>Call Forwarding</b>	
external number (MSN/DDI) .....	28
special dial tone .....	38
subscriber/telephone .....	25
<b>Call Through</b> .....	51
<b>Call Waiting</b>	
switching on/off .....	24
<b>Call Waiting, internal</b> .....	11
<b>CAPI 2.0</b> .....	58
<b>CCBS</b> .....	14
<b>CCNR</b> .....	13
<b>Central Telephone (Waiting Field)</b> .....	48

**Charges**

account .....	31
automatic Least Cost Routing .....	31
delete .....	32
enquire account status .....	32
enquire own sum .....	32
enquire sum .....	32

**Cleaning** .....

64

**COMlist** .....

61

**Computer Connection** .....

58

**COMtools** .....

60

**Conference**

finish .....

start .....

**Configuration dependent  
Programming** .....

23

**Configuration Switching**

automatic .....

enquire status .....

manual .....

**Connection**

analog telephones .....

ISDN telephones .....

PC .....

to the serial port .....

**Continuous Call Data Output**  Select Operation Mode of the  
  Serial Interface .....

34

**Continuous Call Data Printing**

start/stop .....

start/stop command .....

**Cost Control**

call allowance .....

Least Cost Routing .....

**Cost Controls**

Call Through .....

51

**D****D-Channel Protocol Output**  Select Operation Mode of Serial  
  Interface (V.24) .....

34

**Dial Assistance** .....

emergency call .....

**Dial Method**

Learning .....

63

**Dial Tone Configuration** .....

37

**Dial Tone Type**

listen .....

select .....

38

37

**Dialling Assistance**

emergency call .....

35

**Differences**

usage of DTMF, pulse dial and ISDN .....

9

**Direct Exchange Line Telephone**

external call .....

internal call .....

11

**Do-not-Disturb** .....

ignore .....

special dial tone .....

switching on/off .....

30

38

30

**Door Alternation**

during a door call .....

22



<b>Door Bell Key</b>	
signalling .....	21
<b>Door Call</b>	
start .....	22
start when door bell rings .....	21
<b>Door Call incoming</b>	
door bell rings .....	21
telephone rings .....	21
<b>Door Functions</b> .....	21
door to external call .....	41
External Call Forwarding .....	41
<b>Door Opener</b>	
activate in a door call .....	22
<b>DTMF Telephone</b>	
FLASH time .....	63
learning the dial method .....	63
usage .....	9
<b>E</b>	
<b>Emergency Short-Code Dial Numbers</b> ..	35
store .....	35
<b>Enquire Firmware Version</b> .....	63
<b>Enquiry of Settings</b> .....	9
<b>Exchange Line</b>	
reserve on busy exchange line .....	14
<b>Exchange Line Access</b>	
business .....	11
direct/fast .....	11
private .....	49
<b>Exchange Line Access Number</b> .....	11
<b>Exchange Line Authorization</b>	
extend with release numbers .....	60
extend with short-code dial authorization .....	60
<b>External Call</b> .....	10
accepting .....	10
business call .....	11
park on a Point-to-Multipoint connection .....	16
parking on the external S <sub>0</sub> port .....	16
parking on the Point-to-Multipoint connection .....	16
private .....	49
receiving a call .....	10
start business call .....	11
suppress number presentation .....	12
take the call .....	10
via short-code dialling .....	12
with project assignment .....	50
with the door terminal .....	41
<b>External Music on Hold</b> .....	44
<b>External Password</b> .....	27
<b>F</b>	
<b>Filling Status Call Data Memory</b> .....	38
<b>Firmware</b>	
enquire version .....	63
perform update .....	62
<b>Firmware update</b>	
enquire firmware version .....	63
<b>FLASH-Key</b> .....	9
<b>Follow-Me</b> .....	27

<b>Forward Door Terminal Calls</b>	
external telephones .....	41
internal telephones .....	41

**G**

<b>Group</b>	
log in/out .....	52
<b>Group Call Forwarding</b>	
program call forwarding from external telephone .....	55

**H**

<b>Help</b>	
malfunctions .....	64
<b>Hot Line</b> .....	39
<b>Hotel Functions</b> .....	56

**I**

<b>Installation</b>	
PC software .....	59
<b>Instructions for using the Manual</b> .....	8
<b>InterCom</b>	
usage .....	50
<b>Interface</b> .....	58
<b>Internal Call</b> .....	10
accept .....	10
start .....	11
<b>Internal Call Waiting</b> .....	11
<b>Internal Music on Hold</b>	
change .....	44
listen to it .....	46
<b>Internal Tones</b>	
configure dial tones .....	37
listen .....	38
special dial tones .....	38
<b>ISDN Features</b> .....	8
<b>ISDN PC-controller</b>	
for programming (CAPI 2.0) .....	58
<b>ISDN Telephone</b>	
connection .....	63
usage .....	9

**L**

<b>Least Cost Routing</b>	
automatic .....	31
<b>Listen</b>	
to dial tones .....	38
to ringer rhythm .....	39
<b>Listen to</b>	
Music on Hold/announcement .....	46
<b>Log into Group</b> .....	53
<b>Log out of Group</b> .....	53

**M**

<b>Manual Configuration Switching</b>	
usage .....	23
<b>MSN/DDI Call Forwarding</b>	
de/activate .....	28
de/activate from external telephone .....	29
<b>Music Functions</b>	
change Music on Hold .....	44
listen to Music on Hold .....	46
<b>Music on Hold</b>	
change .....	44
listen to it .....	46
record announcement .....	45

**N**

<b>Numbers</b>	
suppress presentation from call to call ...	12

**O**

<b>Open Query</b> .....	17
<b>Operation Mode of the Serial Interface (V.24)</b> .....	34
<b>Output of Call Data</b>	
on demand .....	33
Select Operation Mode of the Serial Interface .....	34
start/stop .....	33

**P**

<b>Parking</b>	
on the external S <sub>0</sub> port .....	16
on the Point-to-Multipoint connection .....	16
<b>Parking External Call</b> .....	16
<b>Parking on a PtMP Connection</b>	
configure code digits .....	47
<b>Password</b>	
external .....	27
private .....	50
public .....	23
secret .....	33
<b>PBX Firmware Update</b>	
starting .....	62
<b>PBX Software Update</b>	
enquire firmware version .....	63
<b>PC Connection</b> .....	58
<b>PC minimum Requirements</b>	
software .....	59
<b>PC Program</b>	
Soft-LCR .....	61
<b>PC program</b>	
COMlist .....	61
COMtools .....	60
Soft-LCR .....	61
<b>PC Software</b>	
install .....	59
<b>Pick-up</b>	
in a call .....	16

- Printing**
    - Hotel Function ..... 56
  - Printing of Call Data**
    - start/stop ..... 33
  - Printout of Call Data**
    - on demand ..... 33
    - start/stop ..... 33
  - Priority Call**
    - Starting ..... 14
  - Private Call**
    - start ..... 49
  - Private Calls** ..... 49
  - Private Password** ..... 50
  - Private Short-Code Dial Number**
    - store ..... 35
  - Programming**
    - by the service technician ..... 62
    - configuration dependent ..... 23
    - from remote ..... 62
    - via serial port ..... 58
    - with ISDN PC-controller (CAPI 2.0) ..... 58
  - Project** ..... 49
  - Project assignment** ..... 50
  - Public Password** ..... 23
  - Pulse Dial Telephone**
    - learning the dialling method ..... 63
    - usage ..... 9
- Q**
- Query**
    - start conference ..... 20
- R**
- Recall**
    - finish ..... 19
    - start internal on no reply ..... 13
  - Reception** ..... 56
  - Record Announcements**
    - Alarm ..... 47
    - Music on Hold ..... 45
  - Redirection** ..... *see* Call Forwarding
  - Registration**
    - call data ..... 32
  - Relay**
    - remote switching ..... 41
  - Release Numbers** ..... 60
  - Remote Programming** ..... 62
  - Remote Switching**
    - from external telephone ..... 42
  - Reservation**
    - an exchange line on busy ..... 14
  - Retrieve parked external Call** ..... 16
  - Ringer Rhythm**
    - change for external calls ..... 39
    - change for internal calls ..... 39
    - listen ..... 39
    - select external ..... 39
    - select internal ..... 39
- R-Key**
- DTMF (FLASH-Key) ..... 9
  - ISDN ..... 9
- Room Monitoring** ..... 40
- Room Status (Hotel Function)** ..... 57
- Room Telephone** ..... 56
- S**
- Safety Functions** ..... 43
  - Serial Interface**
    - Connection ..... 58
  - Serial Port (V.24)**
    - Select Operation Mode ..... 34
  - Short-Code Dial Authorization** ..... 60
  - Short-Code Dial Number**
    - dial ..... 12
    - emergency, store ..... 35
    - store emergency numbers ..... 35
    - store private ..... 35
    - store public ..... 35
  - Signal Key** ..... 9
  - SMS** ..... 51
  - Soft-LCR** ..... 61
  - Soft-LCR (PC program)** ..... 61
  - Software**
    - enquire version ..... 63
    - perform update ..... 62
  - Special Dial Tone** ..... 37, 38
  - Start Recall**
    - in public exchange on busy ..... 14
    - internal on busy ..... 14
    - internal, on no reply ..... 13
  - Subscriber Call Forwarding**
    - de/activate from external telephone ..... 27
    - switching on/of from external ..... 27
    - switching on/off ..... 25
  - Suppress**
    - number presentation ..... 24
    - number presentation from call to call ..... 12
  - Switching**
    - activate alarm ..... 43
    - configuration manual ..... 23
    - relay from remote ..... 41
  - Symbols** ..... 2
  - System Telephone Functions** ..... 9
- T**
- Take over**
    - start ..... 10
  - TAPI Operation Mode** ..... 34
  - Telephones**
    - analog, connection ..... 63
    - differences in usage ..... 9
    - ISDN, connection ..... 63
  - Telephoning**
    - 3 partners (conference) ..... 20
    - external ..... 11
    - internal ..... 11
    - short-code dial numbers ..... 12
  - Text before Answering** ..... 48
- Three-Party Call (Conference)**
- finish ..... 20
  - start ..... 20
- Time dependent Programming** ..... 23
- T-Net Telephones**
- FLASH ..... 63
  - supported functions ..... 8
  - usage ..... 9
- Tones**
- change dial tone ..... 37
  - listen ..... 38
  - special dial tone ..... 38
- Transfer**
- both call partners ..... 19
  - in a Query ..... 19
  - to 3rd call partner ..... 18
  - to an unknown target ..... 17
  - via Waiting Field ..... 48
  - with prior notice ..... 17
  - within conference ..... 20
- Transmission**
- suppress for number from call to call ..... 12
  - suppress for numbers ..... 24
- Troubleshooting** ..... 64
- U**
- Update**
    - enquire firmware version ..... 63
    - PBX software ..... 62
  - Usage**
    - differences between DTMF, pulsed dial and ISDN ..... 9
- V**
- V.24 Port**
    - select operation mode ..... 34
  - Version Firmware**
    - enquire ..... 63
  - VIP** ..... 60
  - VIP List** ..... 30
  - VIP Numbers** ..... 60
- W**
- Waiting Field** ..... 48
  - Waiting Loop** ..... 48
  - Wake-Up Function** ..... 35





884239 04 09/06  
Save the earth – 100 % recycled paper

